



FAI Sporting Code

*Fédération
Aéronautique
Internationale*

Section 4 – Aeromodelling

Volume F3 Radio Control Aerobatics

2021 Edition

Effective 1st January 2021

F3A - R/C AEROBATIC AIRCRAFT
F3P - R/C INDOOR AEROBATIC AIRCRAFT
F3S - R/C JET AEROBATIC AIRCRAFT (PROVISIONAL)
F3M - R/C LARGE AEROBATIC AIRCRAFT (OFFICIAL)
ANNEX 5A - F3A DESCRIPTION OF MANOEUVRES
ANNEX 5B - F3 R/C AEROBATIC AIRCRAFT
MANOEUVRE EXECUTION GUIDE
ANNEX 5G - F3A UNKNOWN MANOEUVRE SCHEDULES
ANNEX 5C - F3M FLYING AND JUDGING GUIDE
ANNEX 5M - F3P DESCRIPTION OF MANOEUVRES
ANNEX 5X - F3S DESCRIPTION OF MANOEUVRES
ANNEX 5N - F3A, F3P, F3M WORLD CUP RULES

*Maison du Sport International
Avenue de Rhodanie 54
CH-1007 Lausanne
Switzerland
Tel: +41(0)21/345.10.70
Fax: +41(0)21/345.10.77
Email: sec@fai.org
Web: www.fai.org*

FEDERATION AERONAUTIQUE INTERNATIONALE

MSI - Avenue de Rhodanie 54 – CH-1007 Lausanne – Switzerland

Copyright 2021

All rights reserved. Copyright in this document is owned by the Fédération Aéronautique Internationale (FAI). Any person acting on behalf of the FAI or one of its Members is hereby authorised to copy, print, and distribute this document, subject to the following conditions:

- 1. The document may be used for information only and may not be exploited for commercial purposes.**
- 2. Any copy of this document or portion thereof must include this copyright notice.**
- 3. Regulations applicable to air law, air traffic and control in the respective countries are reserved in any event. They must be observed and, where applicable, take precedence over any sport regulations.**

Note that any product, process or technology described in the document may be the subject of other Intellectual Property rights reserved by the Fédération Aéronautique Internationale or other entities and is not licensed hereunder.

RIGHTS TO FAI INTERNATIONAL SPORTING EVENTS

All international sporting events organised wholly or partly under the rules of the Fédération Aéronautique Internationale (FAI) Sporting Code¹ are termed *FAI International Sporting Events*². Under the FAI Statutes³, FAI owns and controls all rights relating to FAI International Sporting Events. FAI Members⁴ shall, within their national territories⁵, enforce FAI ownership of FAI International Sporting Events and require them to be registered in the FAI Sporting Calendar⁶.

An event organiser who wishes to exploit rights to any commercial activity at such events shall seek prior agreement with FAI. The rights owned by FAI which may, by agreement, be transferred to event organisers include, but are not limited to advertising at or for FAI events, use of the event name or logo for merchandising purposes and use of any sound, image, program and/or data, whether recorded electronically or otherwise or transmitted in real time. This includes specifically all rights to the use of any material, electronic or other, including software that forms part of any method or system for judging, scoring, performance evaluation or information utilised in any FAI International Sporting Event⁷.

Each FAI Air Sport Commission⁸ may negotiate agreements, with FAI Members or other entities authorised by the appropriate FAI Member, for the transfer of all or parts of the rights to any FAI International Sporting Event (except World Air Games events⁹) in the discipline¹⁰, for which it is responsible¹¹ or waive the rights. Any such agreement or waiver, after approval by the appropriate Air Sport Commission President, shall be signed by FAI Officers¹².

Any person or legal entity that accepts responsibility for organising an FAI Sporting Event, whether or not by written agreement, in doing so also accepts the proprietary rights of FAI as stated above. Where no transfer of rights has been agreed in writing, FAI shall retain all rights to the event. Regardless of any agreement or transfer of rights, FAI shall have, free of charge for its own archival and/or promotional use, full access to any sound and/or visual images of any FAI Sporting Event. The FAI also reserves the right to arrange at its own expense for any and all parts of any event to be recorded.

-
- 1 FAI Statutes,Chapter 1,para. 1.6
 - 2 FAI Sporting Code, Gen. Section,Chapter 4, para 4.1.2
 - 3 FAI Statutes,Chapter 1,para 1.8.1
 - 4 FAI Statutes,Chapter 2,para 2.1.1; 2.4.2; 2.5.2 and 2.7.2
 - 5 FAI By-Laws,Chapter 1,para 1.2.1
 - 6 FAI Statutes,Chapter 2,para 2.4.2.2.5
 - 7 FAI By-Laws,Chapter 1,paras 1.2.2 to 1.2.5
 - 8 FAI Statutes,Chapter 5,paras 5.1.1, 5.2, 5.2.3 and 5.2.3.3
 - 9 FAI Sporting Code, Gen. Section,Chapter 4, para 4.1.5
 - 10 FAI Sporting Code, Gen. Section,Chapter 2, para 2.2.
 - 11 FAI Statutes,Chapter 5,para 5.2.3.3.7
 - 12 FAI Statutes,Chapter 6,para 6.1.2.1.3

PAGE DELIBERATELY LEFT BLANK

VOLUME F3 AEROBATICS

SECTION 4C – MODEL AIRCRAFT – F3 – RADIO CONTROL AEROBATICS

Part Five – Technical Regulations for Radio Controlled Contests

- 5.1. Class F3A -R/C Aerobatic Aircraft
- 5.10 Class F3M -R/C Large Aerobatic Aircraft (Official)
- 5.9 Class F3P -R/C Indoor Aerobatic Aircraft
- 5.12 Class F3S -R/C Jet Aerobatic Aircraft (Provisional)
- Annex 5A F3A -Description of Manoeuvres
- Annex 5B F3A -R/C Aerobatic Aircraft Manoeuvre Execution Guide
- Annex 5G - F3A -Unknown Manoeuvre Schedules
- Annex 5C F3M – Flying and Judging Guide
- Annex 5M - F3P -Description of Manoeuvres
- Annex 5X - F3S -Description of Manoeuvres
- Annex 5N - F3A -World Cup Rules

THIS 2021 EDITION INCLUDES THE FOLLOWING AMENDMENTS MADE TO THE 2020 VOLUME.

These amendments are marked by a double line in the right margin of this edition, in addition to the marked amendments made in 2019.

Four-Year Rolling Amendments for Reference			
Paragraph	Plenary meeting approving change	Brief description of change	Change incorporated by
Numerous throughout.	n/a (2020)	Corrections to minor grammatical errors and numbering. Not marked.	Peter Ulhig Subcommittee Chairman & Kevin Dodd Technical Secretary
F3A			
A-23.04, A-23.07, A-23.16, P-23.07, P-23.15, P.23.16, P-23.17, F-23.04, F-23.11, F-23.14,		Clarifications: These have been marked and include exit instructions and small corrections or additions to manoeuvre descriptions or titles.	
Annex 5A		Updated <i>Explanation of Aresti Symbols</i> diagram.	
F3S			
SB-19.03, SB-19.05		Clarifications: These have been marked. One word 'downline' changed to 'upline' and ¼ changed to 1/8.	

Paragraph	Plenary meeting approving change	Brief description of change	Change incorporated by
F3A	2019		Peter Ulhig Subcommittee Chairman & Kevin Dodd Technical Secretary
5.1.2 f)		Restriction to noise measurement in windy conditions.	
5.1.10 i)		Added paragraph i) regarding 'Judges' Assistants', then consequent renumbering.	
5.1.8 c)		Consequence of 5.1.10 i) above.	
5.1.8 e)		Clarification – the addition of 'middle of the' runway ...	
5.1.8 g)		Clarification – in the case of majority 'Not Observed'.	
5.1.8 m)		More precise wording	
5.1.9 a)		More precise wording	
5.1.9 b)		Change from four to three final rounds.	
5.1.9 a)		Consequence of 5.1.9 b) above.	
5.1.11 f)		Further consequence of 5.1.9 b) above.	
5.1.9 d)		Removal of redundant method of checking software.	
5.1.10 j)		Removal of grouping system for finals.	
5.1.13		Added new schedules of manoeuvres: A-23, F-23, and P-23. Deleted obsolete schedules.	
F3M			
Headings and references to Cat 1 event throughout		F3M is no longer a Championship class but will remain an Official class. Deleted references to Cat 1 event, national team and Team Manager.	
5.10.4		Replaced section – new competition structure.	
5.10.5		Replaced section – addition of an audible signal to start.	
5.10.9 b)		Replaced section – changes to the safety line.	
5.10.10		Delete the entire section 'sound presentation for known and unknown flights'. Consequential renumbering.	
5.10.11 c)		New rule for determining final classification. Consequence of new competition structure.	
5.10.11.1		Deleted section for World and Continental Champs.	
5.10.11.2		Deleted team classification for Cat 1 events. Retained classification for 'open international events' in the note.	
5.10.12		Deleted rules pertaining to judging in Cat 1 events.	
5.10.13 t)		Add a positioning manoeuvre.	
5.10.15		Deleted section regarding final flights, with consequential renumbering below.	
5.10.16.1		Replace the section – new criteria for marking freestyle.	
5.10.16.2	Add a sub-paragraph: safety in the freestyle sequence.		

F3P	2019		Peter Ulhig Subcommittee Chairman & Kevin Dodd Technical Secretary
5.9.13		Add new schedules of manoeuvres: AA-21, AP-21, AF-21. Delete obsolete schedules.	
F3S		Early implementation – effective 15th May 2019	
5.12.1 – 5.12.12		Replaced entire section. More comprehensive description of rules specific to F3S.	
5.12.13		New schedules of manoeuvres: SB-19, SP-19, and SF-19.	
Annexes			
Annex 5A		New F3A schedules. Description of manoeuvres, judging notes and Aresti diagrams.	
Annex 5M		New F3P schedules. Description of manoeuvres, judging notes and Aresti diagrams.	
Annex 5N.3		Allow other combinations of schedules in World Cup competitions, subject to approval.	
Annex 5X	Early implementation – effective 15th May 2019 New F3S schedules. Description of manoeuvres, judging notes and Aresti diagrams.		

Four-Year Rolling Amendments for Reference			
Paragraph	Plenary meeting approving change	Brief description of change	Change incorporated by
F3P	2018	Early implementation – effective 1st June 2018	Peter Ulhig Subcommittee Chairman & Kevin Dodd Technical Secretary
5.9.1 – 5.9.12		More comprehensive description of rules specific to F3P.	
5.9.13		Deleted recommendation that competitors in F3P-AFM should have pre-qualification.	
Annex 5M		More comprehensive judging criteria.	
F3P-AFM		F3P-AFM remains integrated into the F3P Championship class..	

Paragraph	Plenary meeting approving change	Brief description of change	Change incorporated by
F3A	2017		Peter Ulhig Subcommittee Chairman & Kevin Dodd Technical Secretary
5.1.2 d) & f)		Change to permitted sound level metres.	
5.1.2 h)		Clarification to radio equipment rule.	
5.1.8 b)		Change to method of marking – downgrading in 0.5 steps.	
5.1.9 a)		Added procedures for semi-finals and finals in the event of adverse weather conditions.	
5.1.9 c)		Added procedure as practised for junior classification.	
5.1.9 d)		Added procedure for approval of computer tabulation systems.	
5.1.9 e)		Change to normalisation method.	
5.1.9 f)		Deleted sub-paragraph as contents incorporated in 5.1.9 a).	
5.1.11 b), c), h)		Only spread spectrum radio control systems allowed.	
5.1.13		New schedules.	
F3M			
5.10.14 b) 5.10.14 h) -deleted Annex 5L -deleted		Early implementation Rule – 1 June 2017 F3M sequences will be changed every year. They will be published on the CIAM website as soon as they are available. They will no longer be published in this volume.	
F3P			
F3P-AFM	Proposed new provisional status for F3P-AFM.		
5.9.11	Deleted redundant words in consequence of only spread spectrum radio control systems allowed.		
5.9.13	New schedules		

F3S	2017		Peter Ulhig Subcommittee Chairman & Kevin Dodd Technical Secretary
5.12.13		Validity of schedule extended for another two years.	
Annexes			
Annex 5A		New schedules.	
Annex 5B – 5B.2		Change the word 'heading' to 'track'.	
Annex 5B – 5B.4		Change percentages to increase weighting of geometrical accuracy, with resulting decreases to other criteria.	
Annex 5B – 5B.5		Downgrading system for judging manoeuvres – consequence of 5.1.8 b)	
Annex 5B – 5B.8.2 – 5B.8.11 & 5B.10		Required amendments in consequence of change to 5.1.8 b)	
Annex 5B – 5B.8.4		Clarify how to judge loops.	
Annex 5B – 5B.8.5		Early implementation Rule – 1 June 2017 Clarify how to judge roll combinations when the description does not state roll direction.	
Annex 5B – 5B.8.11		Inserted missing word 'stop' in stall-turns.	
Annex 5B – 5B.8.13 (various)		Amended sub-paragraphs as a consequence of change to 5.1.8 b)	
Annex 5L		Deleted	
Annex 5N – 5N.3		Introduced systemised round organisation for World Cup contests to achieve comparability.	
Annex 5N – 5N.4	Simplified wording to explain points allocation to World Cup competitors.		

F3A	n/a		Peter Ulhig Subcommittee Chairman & Kevin Dodd Technical Secretary
5.1.8 g)		Clarification of action following a judge's N.O. mark, with respect to half points accepted for 2018.	
Annexes			
Annex 5A		Clarifications and correct grammar applied to new schedules.	
Annex 5N.3. d)		Clarification. A fourth option added to World Cup guidelines for round organisation.	

Paragraph	Plenary meeting approving change	Brief description of change	Change incorporated by
Page 5 and subsequent references	2016	Deletion of the words "powered model" in the names of the classes in line with 2017 CIAM Classes document.	Kevin Dodd Technical Secretary
Throughout		Upgrade previous cross references to ABR to the corresponding paragraph in CIAM General Rules.	
5.1.2 d) 5.10.2 e) 5.12.2 c)		Deleted. Redundant statement since CIAM General Rules (C.5.1.2) does not now require competitor to build model. Subsequent paragraphs renumbered.	
5N.10		Appropriate form of C.7.4 used for definition of World Cup Board. Refer to CIAM General Rules.	
5.1.13. Annex 5A		Corrected headline of manoeuvre P-19.08 to match the manoeuvre description and Aresti.	
F3P			
5.9.10		More than one panel of judges - combined for final rounds.	

RULE FREEZE FOR THIS VOLUME

With reference to paragraph A.10.2 of CIAM General Rules:

In all classes, the two-year rule for no changes to model aircraft/space model specifications, manoeuvre schedules and competition rules will be strictly enforced. For Championship classes, changes may be proposed in the year of the World Championship of each category.

For official classes without Championship status, the two-year cycle begins in the year that the Plenary Meeting approved the official status of the class. For official classes, changes may be proposed in the second year of the two-year cycle.

- a) changes for F3A and F3P can next be agreed at the Plenary meeting 2021 for application from January 2022;
- b) provisional classes are not subject to this restriction.

The only exceptions allowed to the two-year rule freeze are genuine and urgent safety matters, indispensable rule clarifications and noise rulings.

PAGE DELIBERATELY LEFT BLANK

VOLUME F3 AEROBATICS**PART FIVE – TECHNICAL REGULATIONS FOR RADIO CONTROLLED CONTESTS****5.1. CLASS F3A – RC AEROBATIC AIRCRAFT****5.1.1. Definition of a Radio Controlled Aerobatic Aircraft**

A model aircraft, but not a helicopter, which is aerodynamically manoeuvred in attitude, direction, and altitude by a pilot on the ground using radio control. Variable thrust direction of the propulsion device(s) is not allowed.

General Characteristics of Radio Controlled Aerobatic Model Aircraft shall be verified in processing procedures as per FAI Sporting Code, Section 4, Volume CIAM General Rules, for each participating model aircraft prior to a competition. Not permitted equipment must not be installed.

5.1.2. General Characteristics of Radio Controlled Aerobatic Models:

Maximum overall span..... 2000mm

Maximum overall length..... 2000mm

Maximum total weight, with batteries..... 5000g

- a) A tolerance of 1% will be allowed for possible inconsistencies in measurement instruments for size, weight, and voltage unless otherwise stated.
- b) Propulsion device limitations: Any suitable propulsion device may be utilised. Propulsion devices that are not permitted are those requiring solid expendable propellants, gaseous fuels (at room temperature and atmospheric pressure), or liquefied gaseous fuels. Electric powered model aircraft are limited to a maximum of 42.56 volts for the propulsion circuit, measured off load, and prior to flight while the competitor is in the ready box.
- c) The propulsion device(s) must automatically shut-off or fully idle at the moment an R/C signal failure occurs.
- d) The maximum sound/noise level of the model aircraft and its propulsion device, shall be 94 dB(A) measured at 3m from the centre line of the model aircraft with the model aircraft placed on the ground over concrete, macadam, grass, or bare earth at the flight line. The test shall be carried out with a sound level meter (SLM) complying with IEC 61672 Class 2, or IEC 60651 Type 2.
- e) The tolerance of the sound/noise level measurement is the specified tolerance of the manufacturer of the measuring instrument.
- f) With the propulsion device running at full power, the measurement will be taken 90 degrees on the right-hand side, with the nose of the model aircraft pointing into the wind. The SLM microphone shall be placed on a stand 30cm above the ground in line with the propulsion device. Other than the helper restraining the model aircraft, and the sound steward, no persons or sound/noise reflecting or sound absorbing objects shall be nearer than 3m to the model aircraft or the microphone. The sound/noise measurement shall be made as part of model processing. Electric powered model aircraft must have installed the same batteries for all model processing procedures. The sound test area must be located in a position that does not create a safety hazard to any person around. Noise measurements shall not be taken with wind readings taken over 30 sec of more than 5m/s. Gusts shall be avoided.
- g) In the event of a model aircraft failing the sound/noise test, indication of the result or the reading shall be given to the competitor, and his team manager, and both the transmitter and the model aircraft shall be impounded by a flight line official immediately following the sound test. The competitor and his equipment shall remain under supervision of the flight line official, while modifications or adjustments may be made and the propulsion battery is fully recharged. The model aircraft shall be re-tested under regular operational conditions within 90 minutes by a second noise steward using a second Sound Level Metre, and in the event that the model aircraft fails the re-test, its entire model processing has failed.
- h) Radio equipment shall be of the open loop type (ie no electronic feedback from the model aircraft to the ground except for the stipulations in CIAM General Rules C.16.2.3). Auto-pilot control utilising inertia, gravity or any type of terrestrial or non-terrestrial reference is prohibited. Automatic control sequencing (pre-programming) or automatic control timing devices are prohibited.

Example:

Permitted:

1. Control rate devices that are manually switched by the pilot.
2. Any type of button or lever, switch, or dial control that is initiated or activated and terminated by the competitor.
3. Manually operated switches or programmable options to couple and mix control functions.

Not permitted:

1. Snap roll buttons with automatic timing mode.
2. Pre-programming devices to automatically perform a series of commands.
3. Auto-pilots or gyros for automatic wing levelling or other stabilisation of the model aircraft.
4. Automatic flight path guidance.
5. Propeller pitch change with automatic timing mode.
6. Any type of voice recognition system.
7. Conditions, switches, throttle curves, or any other mechanical or electronic device that will prevent or limit sound level of the propulsion device during the sound/noise test.
8. Any type of learning function involving manoeuvre to manoeuvre or flight to flight analysis.

5.1.3. Definition and Number of Helpers

A helper may be a Team Manager, another competitor, or an officially registered supporter. Each competitor is permitted one helper (usually the caller) during the flight. Two helpers may be present and assist during the starting of the motor(s). One person, either a helper, or the team manager, or the caller, may place the model aircraft for take-off and retrieve the model aircraft following the landing. In exceptional circumstances, another helper may join the competitor and caller/helper during the flight, but only to hold a sun-shield as protection from direct sunlight. These protection devices must not interfere with the judges' vision of the manoeuvres. Physically disabled competitors requiring an additional helper and/or caller or other assistance, must request permission with full details, with their entry, from the organiser of a championship. This additional assistance must be provided by the competitor, must not give him an unfair advantage over other competitors, and must not unduly delay or interfere with the running of the competition. Except for communication between the caller and the competitor, no other performance-enhancing communication with helpers is permitted during the flight.

5.1.4. Number of Flights

Competitors have the right to the same number of preliminary, semi-final, or finals flights. Only completed rounds will be counted. Only when all competitors in the preliminary, semi-final, and final rounds, have had the opportunity to complete the same number of rounds, can the results of the rain-interrupted (or other delay) competition be determined.

5.1.5. Definition of an Attempt

There is an attempt when the competitor is given permission to start.

If the propulsion device fails after the model aircraft becomes airborne, the attempt will be deemed complete.

5.1.6. Number of Attempts

Each competitor is entitled to one attempt for each official flight.

Note: An attempt can be repeated at the contest director's discretion only when any unforeseen reason beyond the control of the competitor, causes the model aircraft to fail to start (eg there is radio interference). Similarly, in a flight that is interrupted by any circumstance beyond the control of the competitor, the competitor is entitled to a reflight, with the entire schedule being flown and judged, but only the affected manoeuvre and the unscored manoeuvres that follow will be tabulated.

This reflight should take place within 30 minutes of the first flight, in front of the same set of judges, or be the first flight after the judges' break, or, if it involves a protest, as soon as the FAI Jury has

deliberated and communicated the outcome of the protest to the contest director. The result of the reflight will be final.

5.1.7. Definition of an Official Flight

There is an official flight when an attempt is made whatever the result.

5.1.8. Marking

- a) Each judge has to assess each manoeuvre and any other relevant action of the competitor individually and independently from the other judges. The criteria for judging are contained in the Description of Manoeuvres (Annex 5M) and in the Manoeuvre Execution Guide (Annex 5B)
- b) Each manoeuvre may be awarded marks by each of the judges during the flight. Every manoeuvre starts with the mark of 10 points and will be downgraded for each defect during the execution of the manoeuvre in one or multiple 0.5 point steps, depending on the severity of the defect. The remaining points result in the mark for the manoeuvre. During tabulation, these marks are multiplied by a coefficient (K-Factor) which relates to the difficulty of the manoeuvre.
- c) Any manoeuvre not completed, or flown out of sequence with the stated schedule shall be scored zero (0). Zero scores need not be unanimous, except in cases where an entirely wrong manoeuvre was performed. When Judging Assistants (according 5.1.10 i) are being utilised, they will inform the Judging panel of any wrong manoeuvres in the flight. Judges must confer after the flight in these cases, bringing it to the attention of the flight line director/contest director on site.
- d) Take-off and landing procedures are not judged and are not scored.
- e) The manoeuvring zone is vertically spread in front of and at a distance of approximately 150 m from the pilot. It is laterally limited by two virtual vertical planes above the extension of two lines on the ground each at an angle of 60 degrees left and right from the intersection of a centre line with the safety line. The centre line is positioned on the ground perpendicular to the safety line on the ground which is parallel to the runway. Two starting circles of 3m diameter are marked on the middle of the runway, one left and one right at minimum 15 m off the centre line, also serving for sound/noise measurement, if required. The upper limit of the manoeuvring zone is defined by the virtual plane stretching up 60 degrees from the ground at the intersection of all ground lines.
- f) The pilot is normally placed on the intersection of all ground lines.
- g) Manoeuvres must be performed such that they can be seen clearly by the judges. If a judge, for some reason beyond the control of the competitor, is not able to follow the model aircraft through the entire manoeuvre, he may set the "Not Observed" (N.O.) mark. In this case, the judge's mark for that particular manoeuvre will be the average of the numerical marks with two digits after the decimal point, rounded up. If the majority of the judges score "Not Observed", the competitor has the right for a reflight as per paragraph 5.1.6. If, for some reason within the control of the competitor, a judge is not able to follow the model aircraft through the entire manoeuvre, he has to downgrade the manoeuvre accordingly.
- h) Centre manoeuvres should be primarily performed in the centre of the manoeuvring zone while turn around manoeuvres should not extend past the lateral limits. Vertical height should not exceed the upper limit. Also, manoeuvres should be primarily performed along a line of flight approximately 150m in front of the safety line. Infractions of this rule will be cause for downgrading by each judge individually and in proportion to the degree of infraction. Exceptions to this rule are cross-box manoeuvres, 3D-manoevres, or manoeuvres in a stalled condition, as well as the horizontal circle manoeuvres which, of necessity, may deviate from the 150m distance of flight.
- i) The manoeuvring zone shall be clearly marked with white (or contrasting colour to the background) vertical poles, approximately 100mm in diameter and approximately 4m high, placed on centre and 60 degrees each side of centre on a line 150m in front of the competitor's position. Flags, streamers, or boards of contrasting colour to the background, should be mounted on the poles to improve visibility. White (or contrasting) lines, originating at the competitor's position and extending outward at least 50m, shall also be used to mark the centre and extreme limits (60 degrees left and right of centre) of the manoeuvring zone. Audible and visual signals to indicate violations of the manoeuvring zone must not be used.

- j) The judges shall be seated not more than 10m, and not less than 7m behind the competitor's position (the apex of the 60 degree lines) and within an area described by the extension of the 60 degree lines to the rear of the competitor. The judges must be seated abreast, usually separated by 2m, with scribes or score secretaries separating them.
- k) At the conclusion of the flight, each judge must independently consider if the in-flight sound level of the model aircraft is too loud. If a majority of the judges consider the in-flight sound level of the model aircraft to be too loud, then the flight score will be penalised by 10 points for each counting judge on that panel during the flight. If, during a flight, the sound level of the model aircraft increases perceptibly as a result of an equipment malfunction, or of a condition initiated by the competitor, the flight line director may request a sound re-test and in the event that the model aircraft fails the re-test, the score for the preceding flight shall be zero. For this re-test, both, the transmitter and the model aircraft shall be impounded by a flight line official immediately following the flight. No modification or adjustment to the model aircraft shall be permitted (other than refuelling or battery recharging). The competitor and his equipment shall remain under supervision of the flight line official. The model aircraft shall be re-tested under regular operational conditions within 90 minutes. If an equipment malfunction during the flight (such as mechanical failure of the exhaust/muffler system) causes excessive noise, the flight line director may request the competitor to land his model aircraft, and scoring will cease from the point of malfunction.
- l) If a model aircraft is, in the opinion of the judges, unsafe or being flown in an unsafe or inappropriate manner, they may bring this to the attention of the flight line director, who may instruct the pilot to land.
- m) The individual manoeuvre scores given by each judge for each competitor must be made public at the end of each flight of competition. The team manager must be afforded the opportunity to check that the scores on each judge's score document correspond to the tabulated scores (to avoid data capture errors). The score board/monitor must be located in a prominent position at the flight line, in full view of the competitors and the public.

5.1.9. Classification

- a) For World and Continental Championships, each competitor will have four preliminary (Schedule P) flights, with the best three normalised scores counting to determine the preliminary ranking. The top half, but not more than 30 competitors, will then have two additional semi-final flights flying the known finals schedule. The total of the best three preliminary flights of semi-finalists (normalised again to 1000 points) will count as one score along with the two semi-finals scores to provide three scores, the best two to count for semi-finals classification.
In the event of adverse weather where flying of all rounds is not possible the classification would be determined on rounds completed as follows:
Preliminaries: one round=one flight counts, two rounds= best one flight counts, three rounds= best two flights count.
Semifinals: one round=the total of the counting preliminary flights (normalised again to 1000 points) with the one semifinals flight count.
Finals: all finished rounds count.
- b) The top ten competitors of the semi-finals of a World or Continental Championship where there is an entry of more than 40 competitors, will then have three additional flights to determine the individual winner. For a World or Continental Championship with less than 40 competitors, the top five competitors will advance to the finals. One final flight will be the current known finals schedule (F) and two will be unknown schedules (two different schedules, UK1 and UK2) (see 5.5). The known and unknown schedules must be flown in the following sequence: Unknown schedule 1, Final schedule F, Unknown schedule 2. The scores of all three schedules will count for final classification. In the case of a tie the semi-final score will be used to decide the higher classification.
- c) The team classification is established at the end of the competition (after the finals) by adding the numerical final placing of the best three team members of each nation. Teams are ranked from the lowest numerical scores to the highest, with complete three-competitor teams, ahead of two-competitor teams, which in turn are ranked ahead of one-competitor teams.

In the case of a tie, the best individual placing decides the team ranking. All competitors matching the junior definition as per CIAM General Rules C.15.6.1 are ranked in an additional junior classification.

- d) For World and Continental Championships, the scores for all rounds, preliminary, semi-finals and finals, will be computed using the Tarasov-Bauer-Long (TBL) statistical averaging scoring system. Only computer tabulation systems containing the TBL algorithm and judge analysis programs that have been Subcommittee approved can be used at World and Continental Championships.
- e) All scores for each round, preliminary, semi-final and finals, will then be normalised as follows: The average score of the top half of competitors flown in front of a particular group of judges (ie a round) shall be awarded 1000 points. The remaining scores for that group of judges are normalised to a percentage of the 1000 points in the ratio of actual score over this average score.

$$\text{Points}_x = \frac{S_x}{S_w} \times 1000$$

Points_x = points awarded to competitor X

S_x = score of competitor X

S_w = average score of top half of competitors in round

Note 1: Final and semi-final flights to determine the individual winner are usually only required for World and Continental Championships. For open international events, national championships, and domestic competitions, the total of the three best preliminary flights out of four or the best two out of three may be used to determine the individual winner and team placing. Flights of Schedule F may be incorporated depending on local circumstances and the time available.

Note 2: The TBL score tabulation system can only be applied for events with at least 5 competitors and 5 judges.

5.1.10. Judging

- a) For a World or Continental Championship with more than 80 competitors, the organiser must appoint four panels of five judges each (a total of twenty judges). The judges must be of different nationalities. Those selected must reflect the approximate geographical distribution of teams participating in the previous World Championship with the final list approved by the CIAM Bureau. At least one third, but not more than two thirds of the judges must not have judged at the previous World Championship. Judge assignment to the four panels will be by random draw.
- b) The invited judges for a World or Continental Championship, must be selected from the applicable list of current or upcoming approved FAI International Judges and must have had a reasonable amount of F3A judging experience of both current P and F schedules, and must submit a résumé of his judging experience to the organiser during the nomination process. The organiser must in turn submit the résumés to the CIAM Bureau for approval.
- c) For the semi-final rounds of a World Championship the judges will be arranged in two groups of ten judges. Assignment to the two groups will be by random draw.
- d) For a World or Continental Championship with 80 or fewer, but more than 40, competitors the organiser must appoint two panels of five judges each (a total of ten judges). The judges must be of different nationalities and must be selected from a current list of FAI International Judges. Judge assignment to the two panels will be by random draw.
- e) For Continental Championships with 40 or fewer competitors, the organiser must appoint a single panel of five judges, with the same selection criteria as above.
- f) For a World or Continental Championship with 80 or fewer, but more than 40, competitors two panels of five judges may be used for the preliminary and semi-final rounds, and one panel of ten judges may be used for the final rounds. For a Continental Championship with 40 or fewer competitors, one panel of five judges may be used for preliminary, semi-final, and final rounds.
- g) The limits of 80/40 competitors may be exceeded under special circumstances provided a reasonable time schedule has been approved by CIAM Bureau.
- h) For open international events or other smaller events, where the TBL statistical averaging scoring system is not used, the highest and lowest marks for each manoeuvre may be

discarded, but only where four or more judges are used. It is recommended that this is applied at national championships, and domestic competitions, too.

- i) For the final rounds of a World or Continental Championship with more than 40 competitors, two "Judges' Assistants" (one from the panel and the reserve judge, if available, or if not two from the panel) will serve to assist the judges. They will inform the Judging panel of any wrong manoeuvres in the flight. Judge assistant assignments will be done by random draw for each final round. Judge assistants assigned from the panel are eligible for only one of the final rounds.
- j) All judges, (except the Judges assistants), will judge all manoeuvres of the final rounds of World and Continental Championships. Electronic scribes have to be used for final rounds.
- k) Before every World or Continental Championship, there shall be a briefing for the judges, followed by training flights by non-competitors. Also, warm-up flights for the judges should be flown by non-competitors before the first official preliminary flight each day. For the semi-finals the highest placing non-semi-finalists and for the finals the highest placing two non-finalists should be awarded the honour of performing the warm-up flights. Warm-up flights should be judged but under no circumstances should they be tabulated. Any deviations from the above procedures must be stated in advance by the organisers and must have prior approval of the CIAM or the CIAM Bureau.

5.1.11. Organisation for Radio Controlled Aerobatics Contests

- a) Members of a National team, who have processed only one model aircraft each, may make use of the second model aircraft processed by another member of the same team. However, once that model has been used by a team member in that competition, it may not be used by any other competitor. If that team member did not process the model aircraft in the first place, then it must be re-registered and re-marked appropriately. This is the responsibility of the team manager.
- b) Only spread spectrum radio control systems are allowed.
- c) The draw for flight order will be done for each flight line. Team members will not be drawn to fly directly after each other. Team members on separate flight lines will be separated by at least two competitors. Competitor identification numbers will only be assigned after this flight order draw, by competitor group, and in numerical ascending order.
- d) For flights two, three and four of the preliminary rounds the flight order will start $\frac{1}{4}$, $\frac{1}{2}$ and $\frac{3}{4}$ down the flight order respectively. Organisers must take care to avoid a flight draw which will cause competitors to fly at approximately the same time each day.
- e) The flight order for the first semi-finals round will also be by random draw. The second semi-finals flight will start $\frac{1}{2}$ down the semi-finals flight order.
- f) The flight order for the first round of the finals will be established by a random draw as above. The flight order for flights two and three will start $\frac{1}{3}$ and $\frac{2}{3}$ down the finals flight order with decimals rounded-up.
- g) Competitors must be called by a flight line official at least five minutes before they are required to occupy the starting area.
- h) The competitor and his helper(s) then occupy the starting area so that a radio check can be performed to verify the correct functioning of the radio control equipment. The competitor must be allowed a maximum of one minute for a radio check before the beginning of the starting time.
- i) The time keeper will audibly notify the competitor when the minute is finished and immediately begin timing the starting time.
- j) According to paragraph 5.1.2., the voltage of the propulsion battery of electric powered models, must be checked by an official in the preparation area before the starting time is started.
- k) For electric powered models, the electric power circuit(s) must not be physically connected, before the starting time is begun and must be physically disconnected immediately after landing.
- l) A competitor is allowed two (2) minutes of starting time and eight (8) minutes of flying time for each flight. The timing of an attempt starts when the contest director, or timekeeper, gives an instruction to the competitor to start and the 2-min starting time begins. The openly displayed timing device/clock will be re-started to count the 8-min flying time when the model aircraft has been placed in the take-off circle. If the model aircraft is not placed with its wheels in the starting circle before/at the expiration of the 2-minute starting time, the contest director/time keeper will advise the competitor and helper that the flight may not proceed. The flight shall score zero points.

With the expiry of the 8-minute flying time, the scoring will cease except for the in-flight sound assessment, which is judged after the model aircraft has landed, irrespective of the time. The contest director/time keeper will advise the pilot, helper, and the judges of the expiry of the 8-minute flying time. The clock will be stopped when the wheels of the model aircraft touch the ground for landing, as proof to the competitor of the recorded time.

- m) The competitor may not start his model aircraft unless he has been instructed by a flight line official to do so. Deliberate starts at the flight line during official flying to check the propulsion device will be subject to disqualification from that round. No public address or commentary should be made during flights.
- n) During the flight, the pilot and his helper/caller (if required) must stay in the designated position in front of the judges, at the convergence of the ground lines and under the supervision of the flight line director. The pilot must wear or display his identification/start number.

5.1.12. Execution of Manoeuvres

- a) The manoeuvres must be executed during an uninterrupted flight in the order in which they are listed in the schedule. The competitor may make only one attempt at each scored manoeuvre during the flight.
- b) The model aircraft must take-off and land unassisted, that is, no hand launched flights. If any part of the model aircraft is jettisoned during the flight, scoring will cease at that point and the competitor must be instructed by the flight line director to immediately land his model aircraft. Usually, the judges will be able to determine when a part has been jettisoned from the model aircraft. They should bring this to the attention of the flight line director on site.
- c) The direction of the first manoeuvre or the landing may be different from that of the take-off.
- d) After take-off, only turn-around manoeuvres, and not more than two (2), are allowed before starting the first manoeuvre of the schedule.

5.1.13. Schedule of Manoeuvres

For 2019-2020 Schedule A-20 is recommended to be flown in local competitions so as to offer advanced pilots a suitable way to achieve skills to step-up to P-21 Schedules.

For 2021-2023 Schedule A-23 is recommended to be flown in local competitions so as to offer advanced pilots a suitable way to achieve skills to step-up to P-23 Schedules.

For 2020-2021 Schedule P-21 will be flown in the preliminaries.

For 2022-2023 Schedule P-23 will be flown in the preliminaries.

For 2020-2021 Schedule F-21 will be flown in the semi-finals, as well as in the finals, together with unknown schedules.

For 2022-2023, Schedule F-23 will be flown in the semi-finals, as well as in the finals, together with unknown schedules.

ADVANCED SCHEDULE A-23 (2021-2023)

	K-Factor
A-23.01 Top Hat with half roll on top	K 3
A 23-02 Half Square Loop	K 2
A-23.03 Push-Pull-Push Humpty-Bump with half roll, half roll	K 3
A-23.04 Half Square Loop on Corner with half roll	K 3
A-23.05 Forty Five Degree Upline with roll	K 4
A-23.06 Half Eight Sided Loop	K 3
A-23.07 Roll Combination with two consecutive half rolls in opposite direction	K 3
A-23.08 Pushed Immelman Turn with half roll	K 2
A-23.09 Inverted Spin two and a half turns	K 4
A-23.10 Pull-Pull-Pull Humpty-Bump, with half roll. (Option: quarter roll, quarter roll)	K 3
A-23.11 Reverse Figure ET	K 3
A-23.12 Square Loop with half roll	K 2
A-23.13 Figure M with quarter rolls	K 5
A-23.14 Trombone	K 3
A.23.15 Triangle with two consecutive quarter rolls, two consecutive quarter rolls	K 3
A-23.16 Shark Fin with half roll	K 3
A-23.17 Loop with knife-edge flight	K 4

Total K = 53

ADVANCED SCHEDULE A-20 (2019-2020)

	K-Factor
A-20.01 Vertical 8	K 3
A-20.02 Stall Turn with consecutive two ¼ rolls	K 3
A-20.03 Square Loop on Corner	K 4
A-20.04 Figure 9	K 3
A-20.05 Knife-Edge flight with ¼ roll, ¼ roll	K 5
A-20.06 Inverted Split S with ½ roll	K 2
A-20.07 Golf Ball	K 5
A-20.08 Shark Fin with ½ roll	K 3
A-20.09 Double Immelman with ½ roll, ½ roll, ½ roll	K 5
A-20.10 Push-Push-Push Humpty-Bump with ½ roll (Option: with ¾ roll, ¼ roll)	K 3
A-20.11 Roll	K 4
A-20.12 Top Hat with spin	K 4
A-20.13 Figure Z	K 4
A-20.14 Comet with ½ roll	K 3
A-20.15 Roll Combination with consecutive two ½ rolls	K 3
A-20.16 Half Square Loop on Corner	K 2
A-20.17 Avalanche	K 4

Total K = 60

PRELIMINARY SCHEDULE P-23 (2022-2023)

	K-Factor
P-23.01 Top Hat with two quarter rolls up, half roll, two quarter rolls down	K 4
P-23.02 Half Square Loop with half roll	K 2
P-23.03 Pull-Pull-Push Humpty-Bump with roll, half roll	K 4
P-23.04 Half Square Loop on Corner with half roll, half roll	K 3
P-23.05 Forty Five Degree Upline, with one and a half snap roll	K 5
P-23.06 Half Eight Sided Loop	K 3
P-23.07 Roll Combination with two consecutive half rolls, two consecutive half rolls in opposite direction	K 4
P-23.08 Pushed Immelman Turn with half roll	K 2
P-23.09 Inverted Spin two and a half turns	K 4
P-23.10 Pull-Pull-Push Humpty-Bump, with half rolls. (Option: three quarter roll, quarter roll)	K 3
P-23.11 Reverse Figure ET with two consecutive half rolls in opposite direction, two consecutive quarter rolls	K 4
P-23.12 Half Square Loop with half roll	K 2
P-23.13 Crossbox Figure M, with three quarter rolls	K 5
P-23.14 Fighter Turn with quarter rolls	K 4
P-23.15 Triangle with half roll, two consecutive quarter rolls, two consecutive quarter rolls, half roll	K 3
P-23.16 Shark Fin with half roll, two consecutive quarter rolls	K 3
P-23.17 Loop with half roll integrated	K 5

Total K = 60

PRELIMINARY SCHEDULE P-21 (2020-2021)

	K-Factor
P-21.01 Vertical 8 with ½ roll, ½ roll	K 3
P-21.02 Stall Turn with consecutive two ¼ rolls	K 3
P-21.03 Square Loop on Corner with ½ roll, ½ roll	K 4
P-21.04 Figure 9 with consecutive two ½ rolls in opposite directions	K 3
P-21.05 Knife-Edge flight with consec. ¼ , ½ roll in opposite directions, consec. ½ , ¼ roll in opposite directions	K 5
P-21.06 Inverted Split S with consecutive two ½ rolls	K 2

P-21.07 Golf Ball with ½ roll integrated	K 5
P-21.08 Shark Fin with consecutive two ¼ rolls	K 3
P-21.09 Double Immelman with ½ roll, consecutive four 1/8 rolls, ½ roll	K 5
P-21.10 Push-Push-Push Humpty-Bump with ½ roll (Option: with ¾ roll, ¼ roll)	K 3
P-21.11 Roll Combination with consecutive ½ roll, roll, ½ roll in opposite directions	K 4
P-21.12 Top Hat with ½ roll, inverted spin (Option: with ¼ roll, ¼ roll)	K 4
P-21.13 Figure Z with roll	K 4
P-21.14 Comet with consecutive two ¼ rolls in opposite directions, ½ roll	K 3
P-21.15 Roll Combination with consecutive four ¼ rolls	K 3
P-21.16 Half Square Loop on Corner with ¼ roll, ¼ roll	K 2
P-21.17 Avalanche	K 4
Total K = 60	

SEMIFINAL/FINAL SCHEDULE F-23 (2022-2023)

	K-Factor
F-23.01 Knife Edge Rolling Loop	K 5
F 23-02 Stall Turn with snap roll, roll	K 4
F-23.03 Eight consecutive 1/8 rolls	K 4
F-23.04 Shark Tooth with three consecutive quarter rolls, three quarter roll	K 3
F-23.05 Square Loop on corner with quarter roll, half roll, half roll, quarter roll	K 5
F-23.06 Push-Pull-Pull Humpty-Bump with consecutive half rolls, integrated roll, snap roll	K 4
F-23.07 Horizontal Eight with rolls integrated	K 6
F-23.08 Reverse Figure ET with half roll, consecutive quarter rolls	K 3
F-23.09 Knife Edge Forty Five Degree Upline with two consecutive snap rolls in opposite direction	K 6
F-23.10 Reverse Vertical Shark Tooth with two consecutive half rolls in opposite direction, two consecutive quarter rolls, roll	K 3
F-23.11 Reverse Double Fighter Turn with three consecutive quarter rolls, half roll, half roll, three consecutive quarter rolls	K 6
F-23.12 Top Hat with half roll, half roll. Option: Top Hat with quarter roll, quarter roll	K 2
F-23.13 Spin with two and a quarter turns, two and a quarter turns in opposite direction	K 5
F-23.14 Half Cuban Eight, with two half rolls in opposite direction, one and half snap roll	K 4
F.23.15 Rolling Circle with half rolls in opposite direction integrated	K 5
F-23.16 Half Square Loop with half rolls in opposite direction	K 2
F-23.17 Avalanche (from top) with half rolls integrated, snap, half roll integrated	K 5
Total K = 72	

FINALS SCHEDULE F-21 (2020 – 2021)

	K-Factor
F-21.01 Golf Ball with ¾ roll, snap roll, ¾ roll	K 4
F-21.02 Half Reverse Cuban 8 with consecutive three ¼ rolls, with the third in opposite direction, ¾ roll	K 3
F-21.03 Horizontal Circle with two ½ rolls opposite in opposite directions integrated	K 4
F-21.04 Top Hat with consecutive three ¼ rolls, ¾ snap-roll	K 4
F-21.05 Pull-Push-Push Humpty-Bump, ¼ roll integrated, roll, consecutive two ½ rolls in opp. Dir., ¼ roll integr.	K 5
F-21.06 Three Quarter Vertical 8 with ½ roll integrated	K 4
F-21.07 Stall-Turn with consecutive ¼ , ½ rolls, ¾ roll	K 4
F-21.08 Figure 9 with 1 ½ snap-roll	K 4
F-21.09 Top-hat with ¾ roll, roll, ¼ roll	K 6
F-21.10 Half Square Loop with ½ roll, consecutive ½ roll, roll	K 3
F-21.11 45° Downline with ¼ roll, consecutive two snap-rolls in opposite directions, ¼ roll	K 6
F-21.12 Half 8-sided Loop with ½ roll, ½ roll	K 3
F-21.13 Loop with consecutive two rolls in opposite directions integrated	K 5

F-21.14 Spin with 2 ½ turns	K 3
F-21.15 Roll Combination with consecutive 1/2 roll, four ¼ rolls in opposite direction, ½ roll in opposite direction.	K 3
F-21.16 Fighter turn, ¾ roll, ¾ snap-roll.	K 4
F-21.17 Horizontal Square Circle with ¼ roll, ½ roll, ½ roll, ½ roll, ¼ roll	K 5
	Total K = 70

ANNEX 5A**F3A – RADIO CONTROLLED AEROBATIC MODEL AIRCRAFT
DESCRIPTION OF MANOEUVRES****ADVANCED SCHEDULE A-23 (2021-2023)****A-23.01 Top Hat with half roll on top**

From upright pull through a quarter loop into a vertical upline, push through a quarter loop, perform a half roll, pull through a quarter loop into a vertical downline, push through a quarter loop, exit inverted

A-23.02 Half Square Loop

From inverted, push through a quarter loop into a vertical upline, push through a quarter loop, exit upright.

A-23.03 Push-Pull-Push Humpty-Bump with half roll, half roll

From upright, fly past center push through a quarter loop into vertical downline, perform a half roll, pull through a half loop into a vertical upline, perform a half roll, push through a quarter loop, exit upright.

A-23.04 Half Square Loop on Corner with half roll

From upright, push through a one eighth loop into a forty five degree downline, perform a half roll, pull through a quarter loop into a forty five degree downline, pull through an eighth loop, exit upright.

A-23.05 Forty Five degree Upline, with roll

From upright, pull through a one eighth loop into a forty five degree upline, perform a roll, push through a one eighth loop, exit upright.

A-23.06 Half Eight Sided Loop

From upright push through a one eighth loop into a forty five degree downline, push through a one eighth loop into a vertical downline, push through a one eighth loop into a forty five degree downline, push through a one eighth loop, exit inverted.

A-23.07 Roll Combination with two consecutive half rolls in opposite direction

From inverted perform consecutively two half rolls in opposite direction, exit inverted.

A-23.08 Pushed Immelman Turn with half roll

From inverted push through a half loop, perform a half roll, exit inverted.

A-23.09 Inverted Spin two and a half turns.

From inverted, perform an inverted spin with two and a half turns, perform a vertical downline, pull through a quarter loop, exit upright.

A-23.10 Pull-Pull-Pull Humpty-Bump, with half roll. Option: (quarter roll, quarter roll)

From upright, pull through a quarter loop into a vertical upline, perform a half roll, pull through a half loop into a vertical downline, pull through a quarter loop, exit upright.

Option: From upright pull through a quarter loop into a vertical upline, perform a quarter roll, pull through a half loop into a vertical downline, perform a quarter roll, pull through a quarter loop, exit upright.

A-23.11 Reverse Figure ET

From upright pull through a one eighth loop into a forty five degree upline, push through a seven eighths loop into a vertical upline, push through a quarter loop, exit upright.

(Note: The vertical line must be in the center.)

A-23.12 Half Square Loop with half roll.

From upright push through a quarter loop into a vertical downline, perform a half roll, pull through a quarter loop, exit upright.

A-23.13 Figure M, with quarter rolls.

From upright pull through a quarter loop into a vertical upline, perform a quarter roll, perform a stall turn into a vertical downline, perform a quarter roll, push through a half loop into a vertical upline, perform a quarter roll, perform a stall turn to a vertical downline, perform a quarter roll, pull through a quarter loop, exit upright.

A-23.14 Trombone

From upright pull through a one eighth loop into a forty five degree upline, perform a half roll, pull through a half loop into a forty five degree downline, pull through a one eighth loop, exit upright.

A-23.15 Triangle with two consecutive quarter rolls, two consecutive quarter rolls

From upright, pull through a three eighths loop into a forty five degree upline, perform consecutively two quarter rolls, push through quarter loop into a forty five degree downline, perform consecutively two quarter rolls, pull through a three eighths loop, exit upright.

A-23.16 Shark Fin with half roll

From upright pull through a quarter loop into a vertical upline, pull through a three eighth loop into a forty five degree downline, perform a half roll, pull through a one eighth loop, exit upright.



A-23.17 Loop with Knife-Edge Flight

From upright pull through a loop with a knife-edge flight over the top ninety degrees, exit upright.



ADVANCED SCHEDULE A-20 (2019-2020)

A-20.01 Vertical 8

From inverted, push through a loop, pull through a loop, exit inverted.

A-20.02 Stall Turn with consecutive two ¼ rolls

From inverted, push through a ¼ loop into a vertical upline, perform a stall turn into a vertical downline, perform consecutively two ¼ rolls, pull through a ¼ loop, exit upright.

A-20.03 Square Loop on Corner

From upright, pull through a 1/8 loop into a 45° upline, pull through a ¼ loop into a 45° upline, pull through a ¼ loop into a 45°downline, pull through a ¼ loop into a 45° downline, pull through a 1/8 loop, exit upright.

A-20.04 Figure 9

From upright, pull through a ¼ loop into a vertical upline, push through a ¾ loop, exit inverted.

A-20.05 Knife-Edge flight with ¼ roll, ¼ roll

From inverted, perform a ¼ roll, perform a knife-edge flight, perform a ¼ roll, exit upright.

A-20.06 Inverted Split S with ½ roll

From upright, push through a ½ loop, perform a ½ roll, exit upright.

A-20.07 Golf Ball

From upright pull through a 1/8 loop into a 45° upline, pull through a ¾ loop into a 45° downline, pull through a 1/8 loop, exit upright.

A-20.08 Shark Fin with ½ roll

From upright, pull through a ¼ loop into a vertical upline, pull through a 3/8 loop into a 45° downline, perform a ½ roll, pull through a 1/8 loop, exit upright.

A-20.09 Double Immelman with ½ roll, ½ roll, ½ roll

From upright perform a ½ roll, push through a ½ loop, perform a ½ roll in the centre, pull through a ½ loop, perform a ½ roll, exit inverted.

A-20.10 Push-Push-Push Humpty-Bump with ½ roll (Option: with ¾ roll, ¼ roll)

From inverted, push through a ¼ loop into a vertical upline, perform a ½ roll, push through a ½ loop into a vertical downline, push through a ¼ loop, exit inverted.

Option: From inverted, push through a ¼ loop into a vertical upline, perform a ¾ roll, push through a ½ loop into a vertical downline, perform a ¼ roll, push through a ¼ loop, exit inverted

A-20.11 Roll

From inverted, perform a roll, exit inverted.

A-20.12 Top Hat with spin

From inverted, push through a $\frac{1}{4}$ loop into a vertical upline, push through a $\frac{1}{4}$ loop into a horizontal line, perform a spin with 2 turns into a vertical downline, pull through a $\frac{1}{4}$ loop, exit upright.

A-20.13 Figure Z

From upright, pull through a $\frac{3}{8}$ loop into a 45° upline, push through a $\frac{3}{8}$ loop, exit upright.

A-20.14 Comet with $\frac{1}{2}$ roll

From upright, push through a $\frac{1}{8}$ loop into a 45° downline, pull through a $\frac{3}{4}$ loop into a 45° downline, perform a $\frac{1}{2}$ roll, pull through a $\frac{1}{8}$ loop, exit upright.

A-20.15 Roll Combination with consecutive two $\frac{1}{2}$ rolls

From upright perform consecutively two $\frac{1}{2}$ rolls, exit upright.

A-20.16 Half Square Loop on Corner

From upright, pull through a $\frac{1}{8}$ loop into a 45° upline, pull through a $\frac{1}{4}$ loop into a 45° upline, pull through a $\frac{1}{8}$ loop, exit inverted.

A-20.17 Avalanche

From inverted pull through a loop while performing a snap roll in the low centre, exit inverted.

PRELIMINARY SCHEDULE P-23 (2022-2023)**P-23.01 Top Hat with two quarter rolls up, half roll, two quarter rolls down**

From upright pull through a quarter loop into a vertical upline, perform consecutively two quarter rolls, pull through quarter loop, perform a half roll, push through a quarter loop into a vertical downline, perform consecutively two quarter rolls, push through a quarter loop, exit inverted.

P-23.02 Half Square Loop with half roll

From inverted, push through a quarter loop into a vertical upline, perform a half roll, pull through a quarter loop, exit inverted.

P-23.03 Pull-Pull-Push Humpty-Bump with roll, half roll

From inverted, fly past center pull through a quarter loop into a vertical downline, perform a roll, pull through a half loop into a vertical upline, perform a half roll, push through a quarter loop, exit upright.

P23.04 Half Square Loop on Corner with half roll, half roll

From upright, push through a one eighth loop into a forty five degree downline, perform a half roll, pull through a quarter loop into a forty five degree downline, perform a half roll, push through a one eighth loop, exit inverted.

P-23.05 Forty Five Degree Upline, with one and a half snap roll

From inverted, push through a one eighth loop into a forty five degree upline, perform one and a half snap roll, push through a one eighth loop, exit upright.

P-23.06 Half Eight Sided Loop

From upright push through a one eighth loop into a forty five degree downline, push through a one eighth loop into a vertical downline, push through a one eighth loop into a forty five degree downline, push through a one eighth loop, exit inverted.

P-23.07 Roll Combination with two consecutive half rolls, two consecutive half rolls in opposite direction

From inverted perform consecutively two half rolls, two half rolls in opposite direction, exit inverted.

P-23.08 Pushed Immelman Turn with half roll

From inverted push through a half loop, perform a half roll, exit inverted.

P-23.09 Inverted Spin two and a half turns

From inverted, perform an inverted spin with two and a half turns, perform a vertical downline, pull through a quarter loop, exit upright.

P-23.10 Pull-Pull-Push Humpty-Bump, with half rolls. (Option: three quarter roll, quarter roll)

From upright, pull through a quarter loop into a vertical upline, perform a half roll, pull through a half loop into a vertical downline, perform a half roll, push through a quarter loop, exit inverted.

Option: From upright pull through a quarter loop into a vertical upline, perform a three quarter roll, pull through a half loop into a vertical downline, perform a quarter roll, push through a quarter loop, exit inverted.

P-23.11 Reverse Figure ET with two consecutive half rolls in opposite direction, two consecutive quarter rolls

From inverted push through a one eighth loop into a forty five degree upline, perform consecutively two half rolls in opposite direction, pull through a seven eighths loop to a vertical upline, perform consecutively two quarter rolls, push through a quarter loop, exit upright.

Note: The vertical line must be in the center

P-23.12 Half Square Loop with half roll

From upright push through a quarter loop into a vertical downline, perform a half roll, pull through a quarter loop, exit upright.

P-23.13 Crossbox Figure M, with three quarter rolls

From upright pull through a quarter loop into a vertical upline, perform a three quarter roll, perform a stall turn into a vertical downline, push through a half loop into a vertical upline, perform a stall turn to a vertical downline, perform a three quarter roll, pull through a quarter loop, exit upright.

P-23.14 Fighter Turn with quarter rolls

From upright pull through a one eighth loop into a forty five degree upline, perform a quarter roll, push through a half knife-edge circle into a forty five degree downline, perform a quarter roll, pull through a one eighth loop, exit upright.

P-23.15 Triangle with half roll, two consecutive quarter rolls, two consecutive quarter rolls, half roll

From upright perform a half roll in the centre, push through a three eighths loop into a forty five degree upline, perform consecutively two quarter rolls, pull through quarter loop into a forty five degree downline, perform consecutively two quarter rolls, push through a three eighths loop, perform a half roll in the centre, exit upright.

P-23.16 Shark Fin with half roll, two consecutive quarter rolls

From upright pull through a quarter loop into a vertical upline, perform a half roll, push through a three eighths loop into a forty five degree downline, perform consecutively two quarter rolls, push through a one eighth loop, exit inverted.

P-23.17 Loop with half roll integrated

From inverted push through a loop while integrating a half roll over the top ninety degrees, exit upright.

PRELIMINARY SCHEDULE P-21 (2020-2021)

P-21.01 Vertical 8 with ½ roll, ½ roll

From inverted, perform a ½ roll ending in the centre, push through a loop, pull through a loop, perform a ½ roll starting in the centre, exit inverted.

P-21.02 Stall Turn with consecutive two ¼ rolls

From inverted, push through a ¼ loop into a vertical upline, perform a stall turn into a vertical downline, perform consecutively two ¼ rolls, pull through a ¼ loop, exit upright.

P-21.03 Square Loop on Corner with ½ roll, ½ roll

From upright, pull through a 1/8 loop into a 45° upline, pull through a ¼ loop into a 45° upline, perform a ½ roll, push through a ¼ loop into a 45°downline, push through a ¼ loop into a 45° downline, perform a ½ roll, pull through a 1/8 loop, exit upright.

P-21.04 Figure 9 with consecutive two ½ rolls in opposite directions

From upright, pull through a ¼ loop into a vertical upline, perform consecutively two 1/2 rolls, in opposite directions, push through a ¾ loop, exit inverted.

cont/ ...



P-21.05 Knife-Edge flight with consecutive $\frac{1}{4}$, $\frac{1}{2}$ roll in opposite directions, consecutive $\frac{1}{2}$, $\frac{1}{4}$ roll in opposite directions

From inverted, perform consecutively a $\frac{1}{4}$ roll and a $\frac{1}{2}$ roll in opposite directions, perform a knife-edge flight, perform consecutively a $\frac{1}{2}$ roll and a $\frac{1}{4}$ roll in opposite directions exit upright.

P-21.06 Inverted Split S with consecutive two $\frac{1}{2}$ rolls

From upright, push through a $\frac{1}{2}$ loop, perform consecutively two $\frac{1}{2}$ rolls, exit inverted.

P-21.07 Golf Ball with $\frac{1}{2}$ roll integrated

From inverted push through a $\frac{1}{8}$ loop into a 45° upline, push through a $\frac{3}{4}$ loop into a 45° downline, while performing a $\frac{1}{2}$ roll integrated in the top 180° , pull through a $\frac{1}{8}$ loop, exit upright.

P-21.08 Shark Fin with consecutive two $\frac{1}{4}$ rolls

From upright, pull through a $\frac{1}{4}$ loop into a vertical upline, pull through a $\frac{3}{8}$ loop into a 45° downline, perform consecutively two $\frac{1}{4}$ rolls, pull through a $\frac{1}{8}$ loop, exit upright.

P-21.09 Double Immelman with $\frac{1}{2}$ roll, consecutive four $\frac{1}{8}$ rolls, $\frac{1}{2}$ roll

From upright perform a $\frac{1}{2}$ roll, push through a $\frac{1}{2}$ loop, perform consecutively four $\frac{1}{8}$ rolls, pull through a $\frac{1}{2}$ loop, perform a $\frac{1}{2}$ roll, exit inverted.

P-21.10 Push-Push-Push Humpty-Bump with $\frac{1}{2}$ roll (Option: with $\frac{3}{4}$ roll, $\frac{1}{4}$ roll)

From inverted, push through a $\frac{1}{4}$ loop into a vertical upline, perform a $\frac{1}{2}$ roll, push through a $\frac{1}{2}$ loop into a vertical downline, push through a $\frac{1}{4}$ loop, exit inverted.

Option: From inverted, push through a $\frac{1}{4}$ loop into a vertical upline, perform a $\frac{3}{4}$ roll, push through a $\frac{1}{2}$ loop into a vertical downline, perform a $\frac{1}{4}$ roll, push through a $\frac{1}{4}$ loop, exit inverted.

P-21.11 Roll Combination with consecutive $\frac{1}{2}$ roll, roll, $\frac{1}{2}$ roll in opposite directions

From inverted, perform consecutively a $\frac{1}{2}$ roll, roll, $\frac{1}{2}$ roll in opposite directions, exit inverted.

P-21.12 Top Hat with $\frac{1}{2}$ roll, inverted spin (Option: with $\frac{1}{4}$ roll, $\frac{1}{4}$ roll)

From inverted, push through a $\frac{1}{4}$ loop into a vertical upline, perform a $\frac{1}{2}$ roll, pull through a $\frac{1}{4}$ loop into a horizontal line, perform a spin with $2\frac{1}{2}$ turns into a vertical downline, pull through a $\frac{1}{4}$ loop, exit upright.

Option: From inverted push through a $\frac{1}{4}$ loop into a vertical upline, perform a $\frac{1}{4}$ roll, pull through a $\frac{1}{4}$ loop into a horizontal line, perform a spin with $2\frac{1}{2}$ turns into a vertical downline, perform a $\frac{1}{4}$ roll, pull through a $\frac{1}{4}$ loop, exit upright.

P-21.13 Figure Z with roll

From upright, pull through a $\frac{3}{8}$ loop into a 45° upline, perform a roll, push through a $\frac{3}{8}$ loop, exit upright.

P-21.14 Comet with consecutive two $\frac{1}{4}$ rolls in opposite directions, $\frac{1}{2}$ roll

From upright, push through a $\frac{1}{8}$ loop into a 45° downline, perform consecutively two $\frac{1}{4}$ rolls in opposite directions, pull through a $\frac{3}{4}$ loop into a 45° downline, perform a $\frac{1}{2}$ roll, pull through a $\frac{1}{8}$ loop, exit upright.

P-21.15 Roll Combination with consecutive four $\frac{1}{4}$ rolls

From upright perform consecutively four $\frac{1}{4}$ rolls, exit upright.

P-21.16 Half Square Loop on Corner with $\frac{1}{4}$ roll, $\frac{1}{4}$ roll

From upright, pull through a $\frac{1}{8}$ loop into a 45° upline, perform a $\frac{1}{4}$ roll, perform a $\frac{1}{4}$ knife-edge loop into a 45° upline, perform a $\frac{1}{4}$ roll, pull through a $\frac{1}{8}$ loop, exit inverted.

P-21.17 Avalanche

From inverted pull through a loop while performing a snap roll in the low centre, exit inverted.

SEMIFINAL/FINAL SCHEDULE F-23 (2022-2023)**F-23.01 Knife Edge Rolling Loop**

From upright, perform a three quarter roll to knife edge, perform a knife edge loop while performing a roll integrated, perform a three quarter roll, exit inverted.

cont/ ...

F-23.02 Stall Turn with snap roll, roll

From inverted, push through a quarter loop into vertical upline, perform a snap roll, perform a stall turn into a vertical downline, perform a roll, push through a quarter loop, exit inverted.

F-23.03 Eight consecutive one eighth rolls

From inverted, perform consecutively eight, one eighth rolls, exit inverted.

F-23.04 Shark Tooth with three consecutive quarter rolls, three quarter roll

From inverted, push through a quarter loop into a vertical upline, perform consecutively three quarter rolls, perform a three eighth knife edge loop into a forty five degree downline, perform a three quarter roll, pull through a one eighth loop, exit upright.

F-23.05 Square Loop on corner with quarter roll, half roll, half roll, quarter roll

From upright, pull through a one eighth loop into a forty five degree upline, perform a quarter roll to knife edge, perform a quarter knife edge loop into forty five degree upline, perform a half roll, perform a quarter knife edge loop into a forty five degree downline, perform a half roll, perform a quarter knife edge loop into a forty five degree downline, perform a quarter roll, push through a one eighth loop, exit inverted.

F-23.06 Push-Pull-Pull Humpty-Bump with consecutive half rolls, integrated roll, snap roll

From inverted, push through a quarter loop into a vertical upline, perform consecutively two half rolls, pull through a half loop with roll integrated into a vertical downline, perform a snap roll, pull through quarter loop, exit upright.

F-23.07 Horizontal Eight with rolls integrated

From upright, fly past center, pull through a three quarter loop while performing the first three quarter roll of two consecutive rolls integrated, then while continuing rolling perform a second loop (one roll integrated), while continuing rolling complete last quarter of first loop (quarter roll integrated), exit upright

F-23.08 Reverse Figure ET with half roll, two consecutive quarter rolls.

From upright, pull through quarter loop into a vertical upline, perform a roll, pull through a five eighths loop into a forty five degree down line, perform consecutively two quarter rolls, pull through a three eighths loop, exit upright.

F-23.09 Knife Edge Forty Five Degree Upline with two consecutive snap rolls in opposite direction

From upright, perform a quarter roll to knife edge, perform a one eighth knife edge loop into a forty five degree upline, perform consecutively two snap rolls in opposite direction, perform a one eighth knife edge loop, perform a quarter roll, exit inverted.

F-23.10 Reverse Vertical Shark Tooth with two consecutive half rolls in opposite direction, two consecutive quarter rolls, roll

From inverted, pull through a quarter loop into a vertical downline, perform consecutively two half rolls in opposite direction, pull through a quarter loop, perform consecutively two quarter rolls, push through a three eighths loop into a forty five degree upline, perform a roll, pull through a three eighths loop, exit inverted.

F-23.11 Reverse Double Fighter Turn with three consecutive quarter rolls, half roll, half roll, three consecutive quarter rolls

From inverted, pull through a one eighth loop into a forty five degree downline, perform consecutively three quarter rolls, push through a half knife edge circle into a forty five degree upline, perform a half roll, perform a quarter knife edge loop into a forty five degree downline, perform a half roll, push through a half knife edge circle into a forty five degree upline, perform consecutively three quarter rolls, pull through a one eighth loop, exit inverted.

F-23.12 Reverse Top Hat with quarter roll, quarter roll. Option: Reverse Top Hat with half roll, half roll

From inverted, pull through a quarter loop into a vertical downline, perform a quarter roll, push through a quarter loop into a horizontal line, push through a quarter loop into a vertical upline, perform a quarter roll, push through a quarter loop, exit upright.

Option: From inverted, pull through a quarter loop into a vertical downline, perform a half roll, push through a quarter loop into a horizontal line, push through a quarter loop into a vertical upline, perform a half roll, push through a quarter loop, exit upright.

F-23.13 Spin with two and a quarter turns, two and a quarter turns in opposite direction

From upright, perform a spin with two and a quarter turns, perform immediately another spin with two and a quarter turns in opposite direction, perform a vertical downline, pull through a quarter loop, exit upright.



F-23.14 Half Cuban Eight, with two half rolls in opposite direction, one and a half snap roll

From upright, perform consecutively two half rolls in opposite direction, pull through a five eighths loop into a forty five degree downline, perform a one and a half snap roll, pull through a one eighth loop, exit upright.

F-23.15 Rolling Circle with half rolls in opposite direction integrated

From upright, perform a rolling circle with two half rolls in opposite direction integrated, first half roll to outside, exit upright.

F-23.16 Half Square Loop with half rolls in opposite direction

From upright, pull through a quarter loop into a vertical upline, perform consecutively two half rolls in opposite direction, pull through a quarter loop, exit inverted.

F-23.17 Avalanche (from top) with half roll integrated, snap, half roll integrated

From inverted, pull through a loop while integrating a half roll in first ninety degree, perform a snap roll at bottom of the loop, perform a half roll integrated in last ninety degree, exit inverted.

FINALS SCHEDULE F-21 (2020 – 2021)

F-21.01 Golf Ball with $\frac{3}{4}$ roll, snap roll, $\frac{3}{4}$ roll

From upright pull through a $\frac{3}{8}$ loop to a 45° upline, perform a $\frac{3}{4}$ roll, perform a $\frac{3}{4}$ knife-edge loop into a 45° downline with a snap-roll on top, perform a $\frac{3}{4}$ roll, pull through a $\frac{3}{8}$ loop to exit upright.

F-21.02 Half Reverse Cuban 8 with consecutive three $\frac{1}{4}$ rolls, with the third in opposite direction, $\frac{3}{4}$ roll

From upright pull through a $\frac{1}{8}$ loop into a 45° upline, perform consecutively three $\frac{1}{4}$ rolls with the third in opposite direction, perform a $\frac{5}{8}$ knife-edge loop, perform a $\frac{3}{4}$ roll, exit inverted. Judging Note: There must be no line between the $\frac{5}{8}$ knife-edge loop and the $\frac{3}{4}$ roll.

F-21.03 Horizontal Circle with two $\frac{1}{2}$ rolls opposite in opposite directions integrated

From inverted perform a horizontal circle with two $\frac{1}{2}$ rolls in opposite directions (first $\frac{1}{2}$ roll to the inside) integrated, exit inverted.

F-21.04 Top Hat with consecutive three $\frac{1}{4}$ rolls, $\frac{3}{4}$ snap-roll

From inverted push through a $\frac{1}{4}$ loop into a vertical upline, perform consecutively three $\frac{1}{4}$ rolls, pull through a $\frac{1}{4}$ loop into a horizontal line, pull through a $\frac{1}{4}$ loop into a vertical downline, perform a $\frac{3}{4}$ snap-roll, pull through a $\frac{1}{4}$ loop, exit upright.

F-21.05 Pull-Push-Push Humpty-Bump, $\frac{1}{4}$ roll integrated, roll, consecutive two $\frac{1}{2}$ rolls in opposite directions, $\frac{1}{4}$ roll integrated

From upright pull through a $\frac{1}{4}$ loop with a $\frac{1}{4}$ roll integrated into a vertical upline, perform a roll, push through a $\frac{1}{2}$ loop into a vertical downline, perform consecutively two $\frac{1}{2}$ rolls in opposite directions, push through a $\frac{1}{4}$ loop with a $\frac{1}{4}$ roll integrated, exit inverted.

F-21.06 Three Quarter Vertical 8 with $\frac{1}{2}$ roll integrated

From inverted push through a half loop and a loop with a $\frac{1}{2}$ roll integrated in the last 45° of the half loop and the first 45° of the loop, exit inverted.

F-21.07 Stall-Turn with consecutive $\frac{1}{4}$, $\frac{1}{2}$ rolls, $\frac{3}{4}$ roll

From inverted pull through a $\frac{3}{4}$ loop into a vertical upline, perform a $\frac{1}{4}$ roll and a $\frac{1}{2}$ roll in opposite direction, perform a stall turn into a vertical downline, perform a $\frac{3}{4}$ roll, push through a $\frac{3}{4}$ loop, exit upright.

F-21.08 Figure 9 with 1 $\frac{1}{2}$ snap-roll

Pull through a $\frac{3}{4}$ loop into a vertical downline, perform 1 $\frac{1}{2}$ snap-roll, pull through a $\frac{1}{4}$ loop, exit upright.

F-21.09 Top-hat with $\frac{3}{4}$ roll, roll, $\frac{1}{4}$ roll

From upright pull through a $\frac{1}{4}$ loop into a vertical upline, perform a $\frac{3}{4}$ roll, perform a $\frac{1}{4}$ knife-edge loop into a horizontal line, perform a roll, perform a $\frac{1}{4}$ knife-edge loop into a vertical downline, perform a $\frac{1}{4}$ roll, pull through a $\frac{1}{4}$ loop, exit upright.

cont/ ...

F-21.10 Half Square Loop with $\frac{1}{2}$ roll, consecutive $\frac{1}{2}$ roll, roll

From upright perform a $\frac{1}{2}$ roll, push through a $\frac{1}{4}$ loop into a vertical upline, perform consecutively a $\frac{1}{2}$ roll, a roll in opposite directions, pull through a $\frac{1}{4}$ loop, exit inverted. Judging Note: There must be no line between the first $\frac{1}{2}$ roll and the $\frac{1}{4}$ loop.

F-21.11 45° Downline with $\frac{1}{4}$ roll, consecutive two snap-rolls in opposite directions, $\frac{1}{4}$ roll

From inverted pull through a $\frac{1}{8}$ loop into a 45° downline, perform a $\frac{1}{4}$ roll, perform consecutively two snap-rolls in opposite directions, perform a $\frac{1}{4}$ roll, push through a $\frac{1}{8}$ loop, exit inverted.

F-21.12 Half 8-sided Loop with $\frac{1}{2}$ roll, $\frac{1}{2}$ roll

From inverted, push through a $\frac{1}{8}$ loop into a 45° upline, perform a $\frac{1}{2}$ roll, pull through a $\frac{1}{8}$ loop into a vertical upline, pull through a $\frac{1}{8}$ loop into a 45° upline, perform a $\frac{1}{2}$ roll, push through a $\frac{1}{8}$ loop, exit upright.

F-21.13 Loop with consecutive two rolls in opposite directions integrated

From upright push through a loop with consecutively two rolls in opposite directions integrated, exit upright.

F-21.14 Spin with 2 $\frac{1}{2}$ turns

From upright perform a spin with 2 $\frac{1}{2}$ turns, pull through a $\frac{1}{4}$ loop, exit upright.

F-21.15 Roll Combination with consecutive 1/2 roll, four $\frac{1}{4}$ rolls in opposite direction, $\frac{1}{2}$ roll in opposite direction.

From upright perform consecutively a $\frac{1}{2}$ roll, four $\frac{1}{4}$ rolls in opposite direction, a $\frac{1}{2}$ roll in opposite direction, exit upright.

F-21.16 Fighter turn, $\frac{3}{4}$ roll, $\frac{3}{4}$ snap-roll

From upright pull through a $\frac{1}{8}$ loop into a 45° upline, perform a $\frac{3}{4}$ roll, push through a $\frac{1}{2}$ circle into 45° downline, perform a $\frac{3}{4}$ snap-roll, pull through a $\frac{1}{8}$ loop, exit upright.

F-21.17 Horizontal Square Circle with $\frac{1}{4}$ roll, $\frac{1}{2}$ roll, $\frac{1}{2}$ roll, $\frac{1}{2}$ roll, $\frac{1}{4}$ roll

From upright perform a $\frac{1}{4}$ roll in the centre, push through a $\frac{1}{4}$ circle, perform a $\frac{1}{2}$ roll, pull through a $\frac{1}{4}$ circle, perform a $\frac{1}{2}$ roll, push through a $\frac{1}{4}$ circle, perform a $\frac{1}{2}$ roll, pull through a $\frac{1}{4}$ circle, perform a $\frac{1}{4}$ roll in the centre, exit upright.

For the Manoeuvre Execution Guide, see Annex 5B.

Examples of Terminology

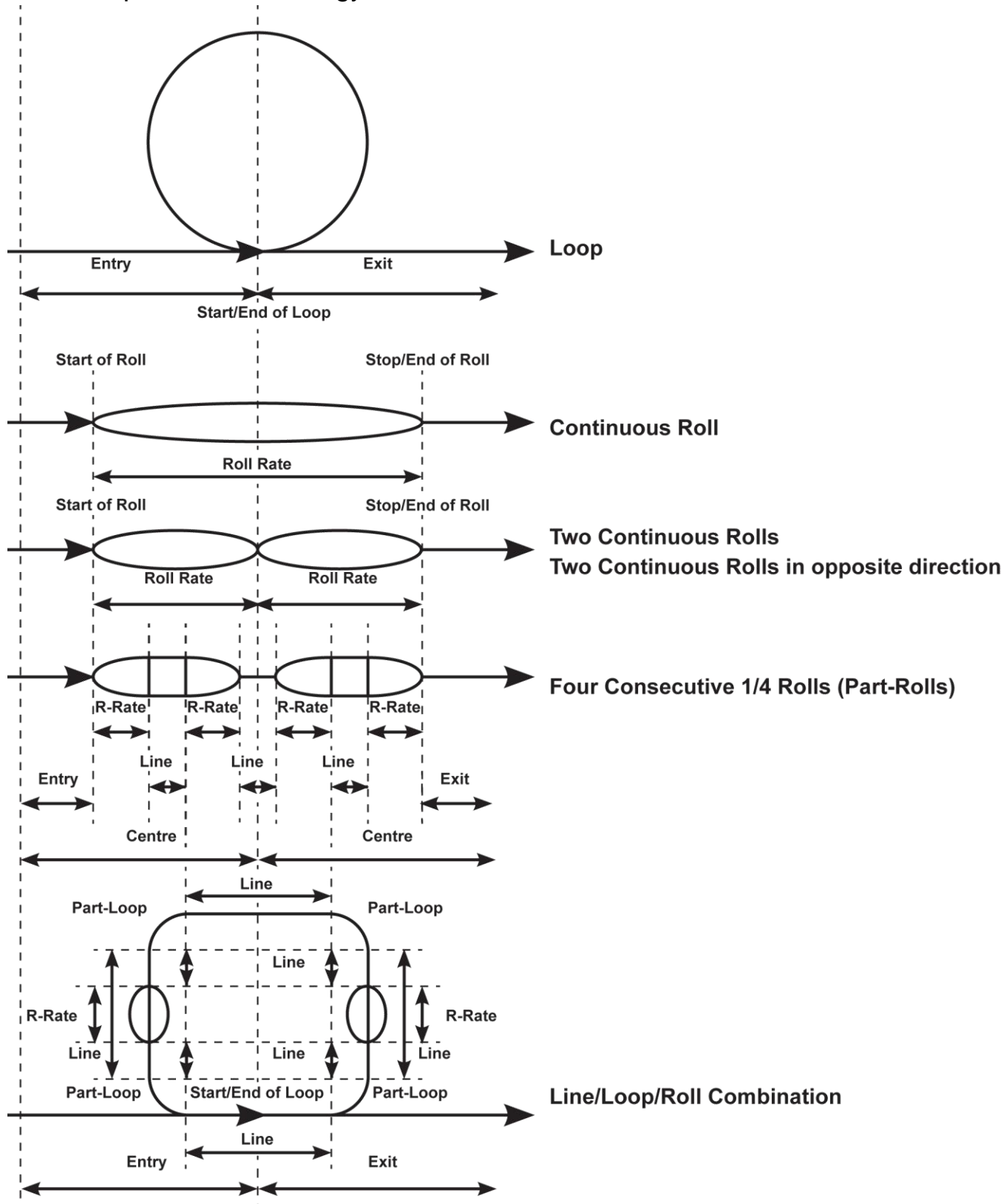

EXPLANATION OF ARESTI SYMBOLS

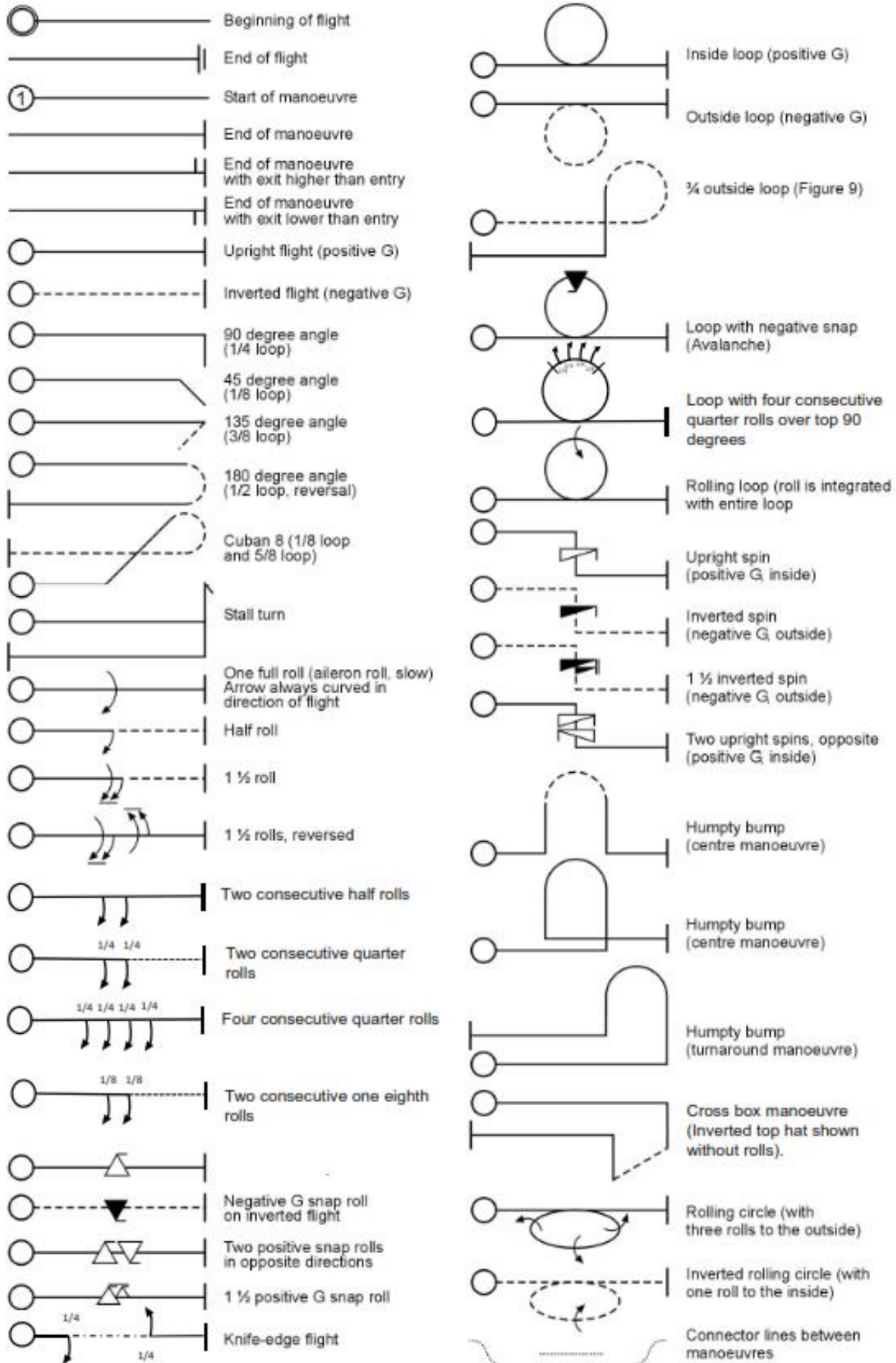

ADVANCED SCHEDULE A-23 (2021-2023)

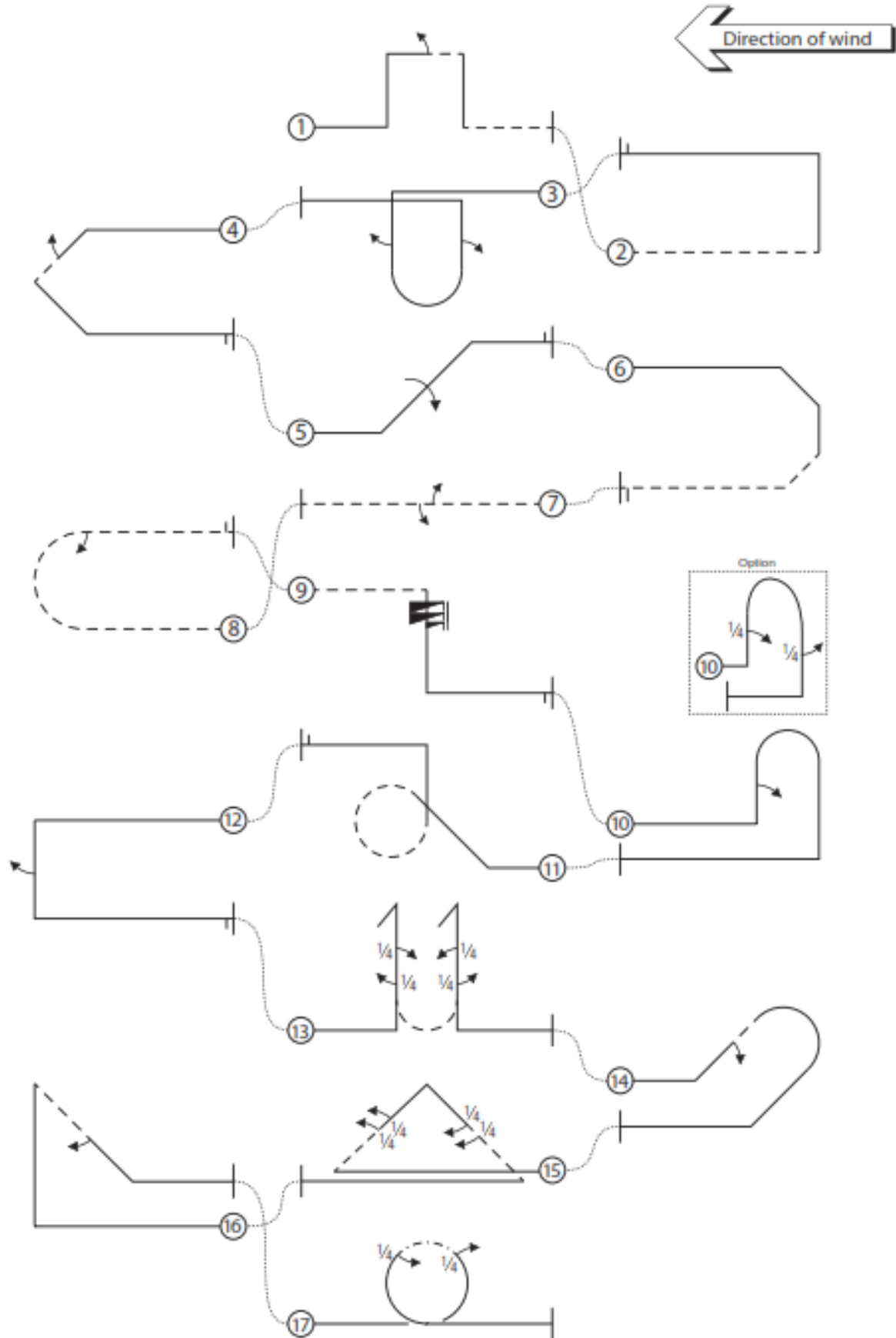

ADVANCED SCHEDULE A-20 (2019-2020)

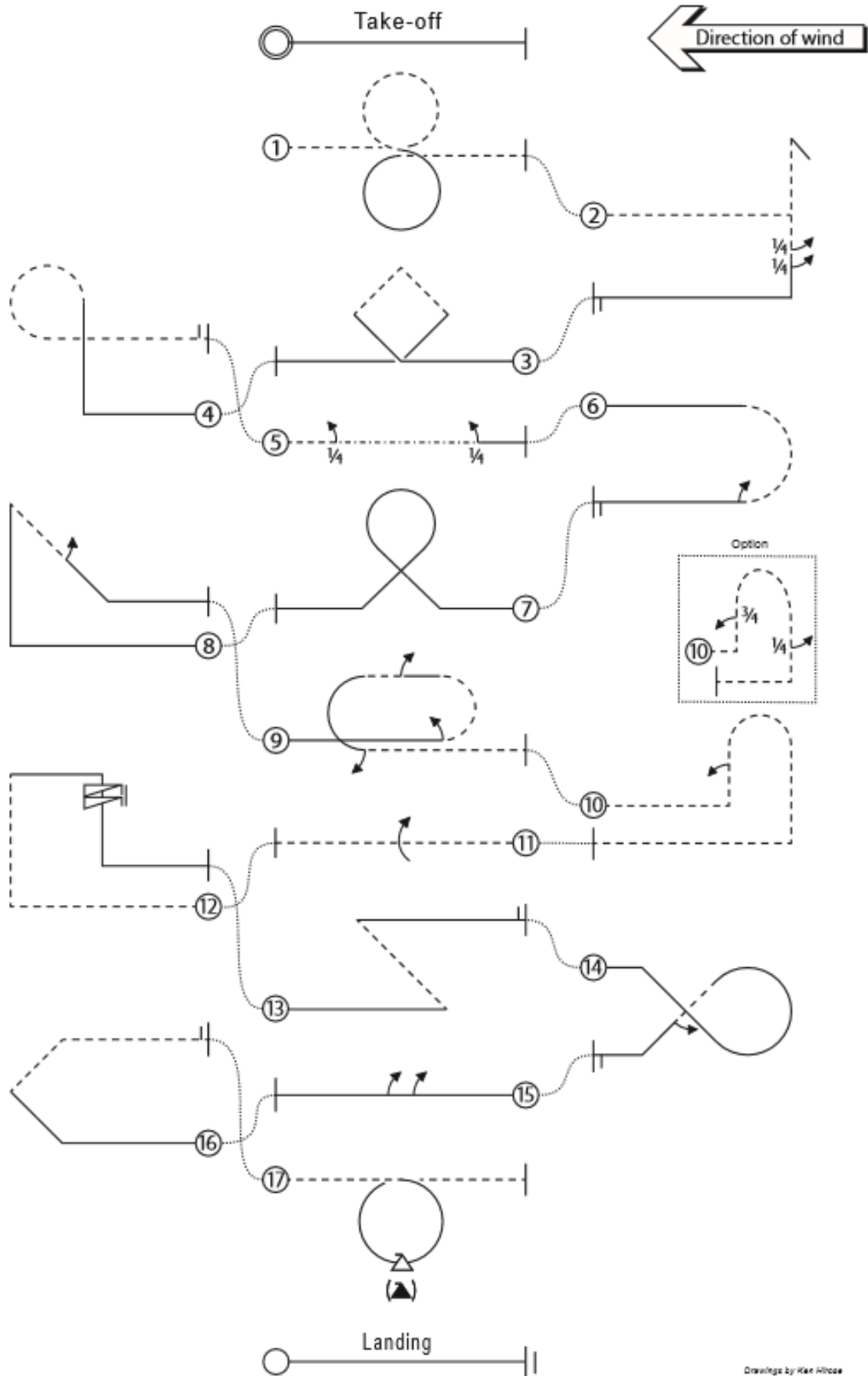

Drawings by Ken Hoose
Feb. 2017

PRELIMINARY SCHEDULE P-23 (2022-2023)

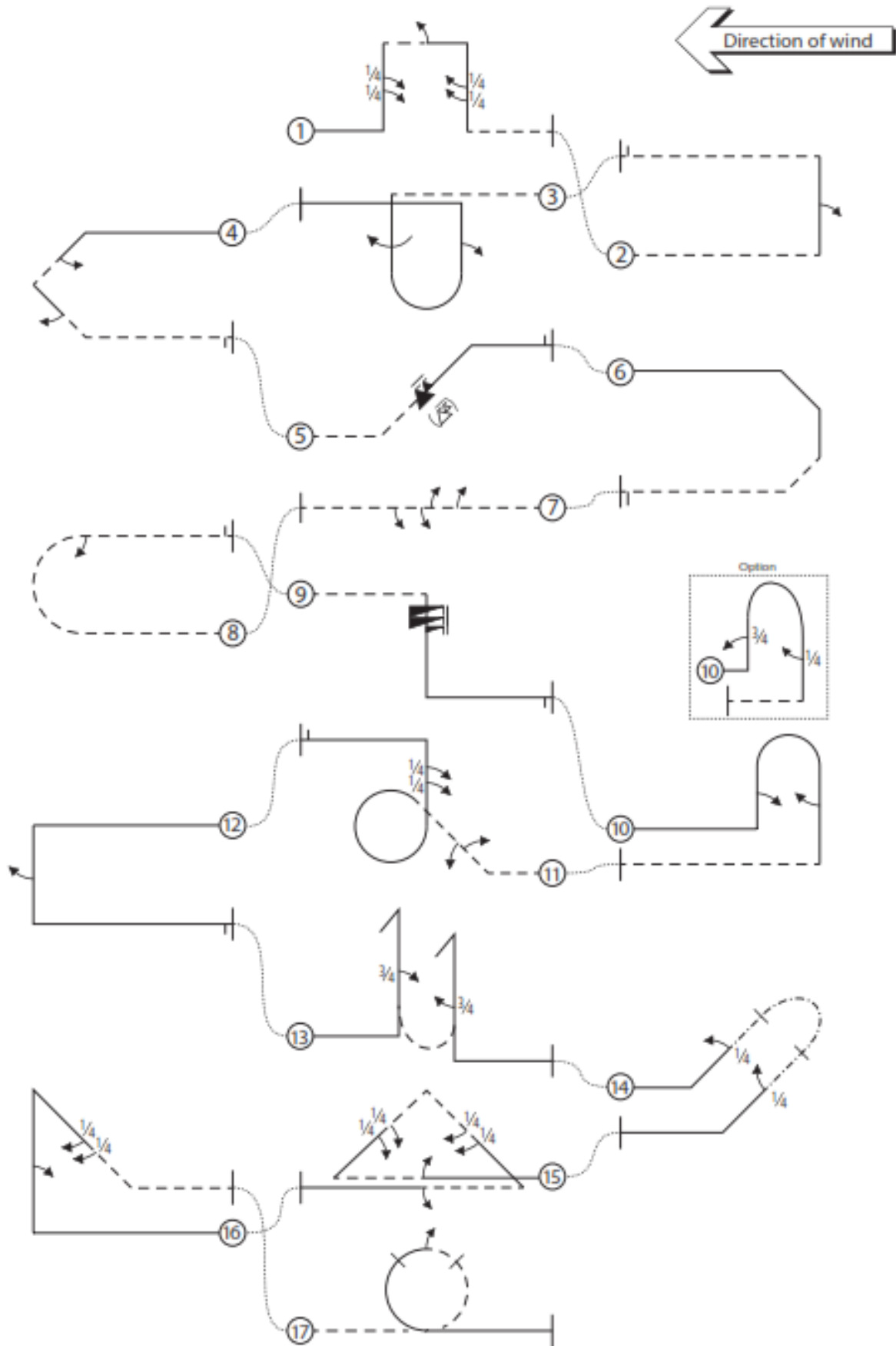

PRELIMINARY SCHEDULE P-21 (2020-2021)

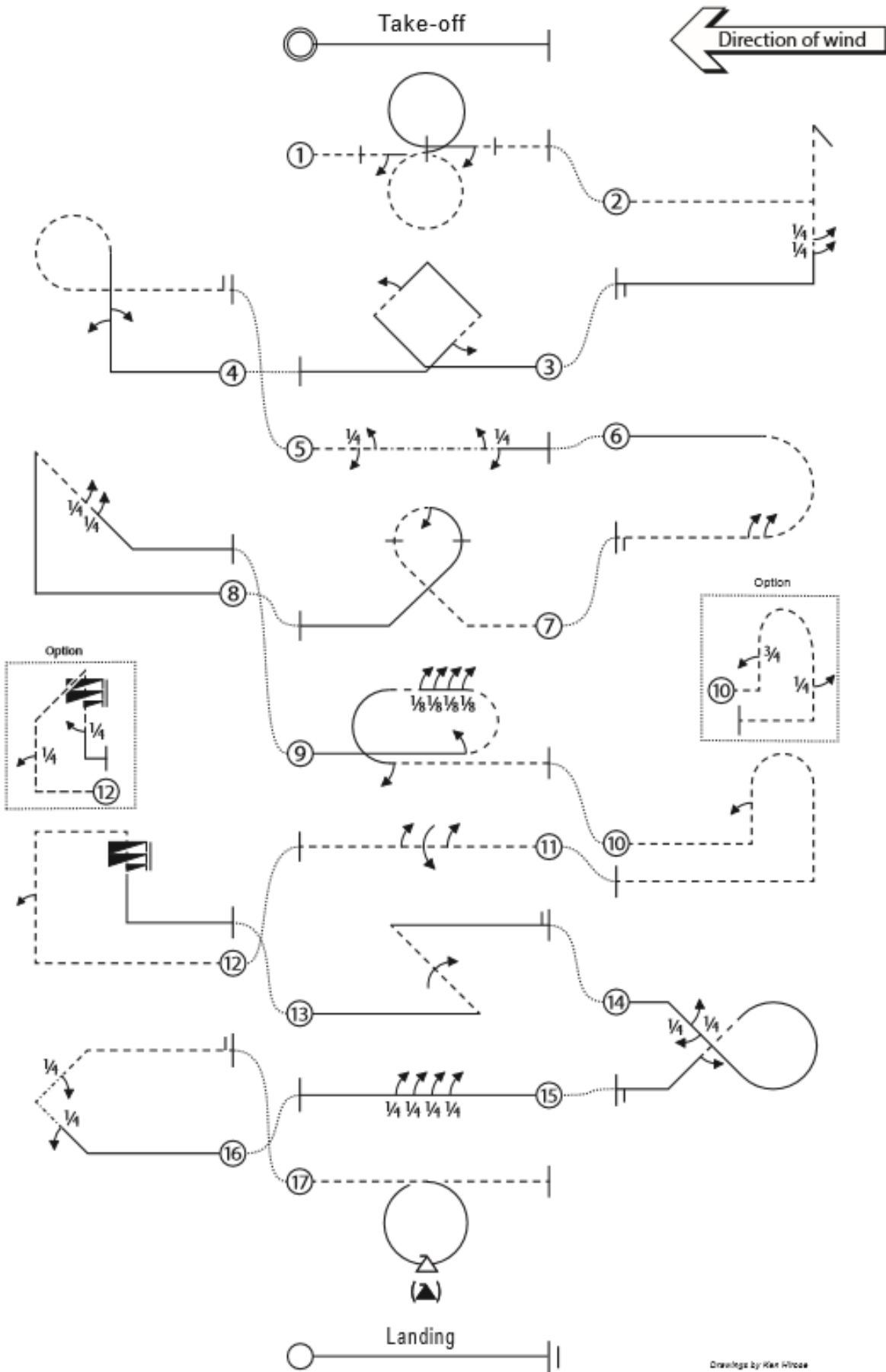

FINAL SCHEDULE F-23 (2021-2023)

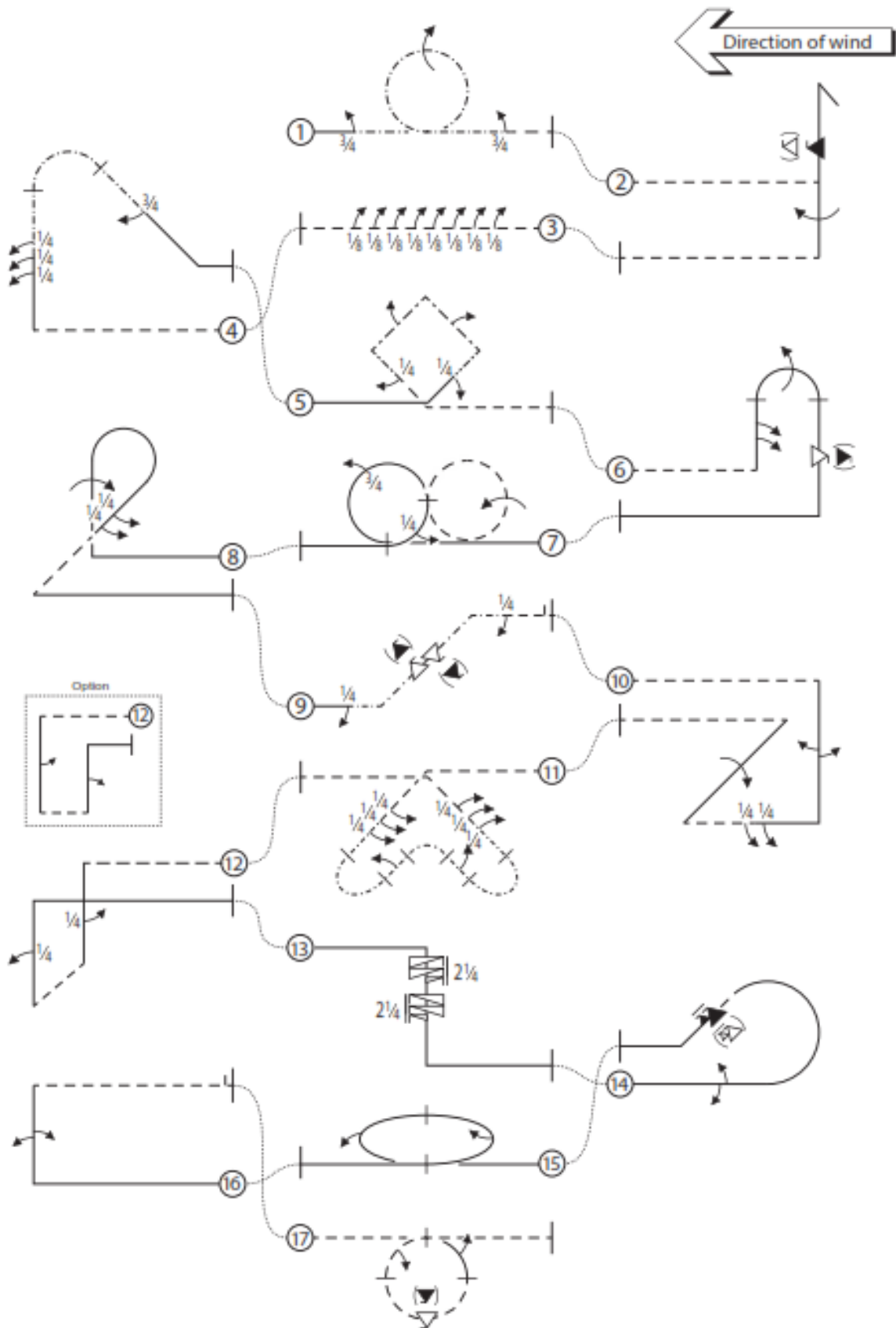

FINAL SCHEDULE F-21 (2020-2021)

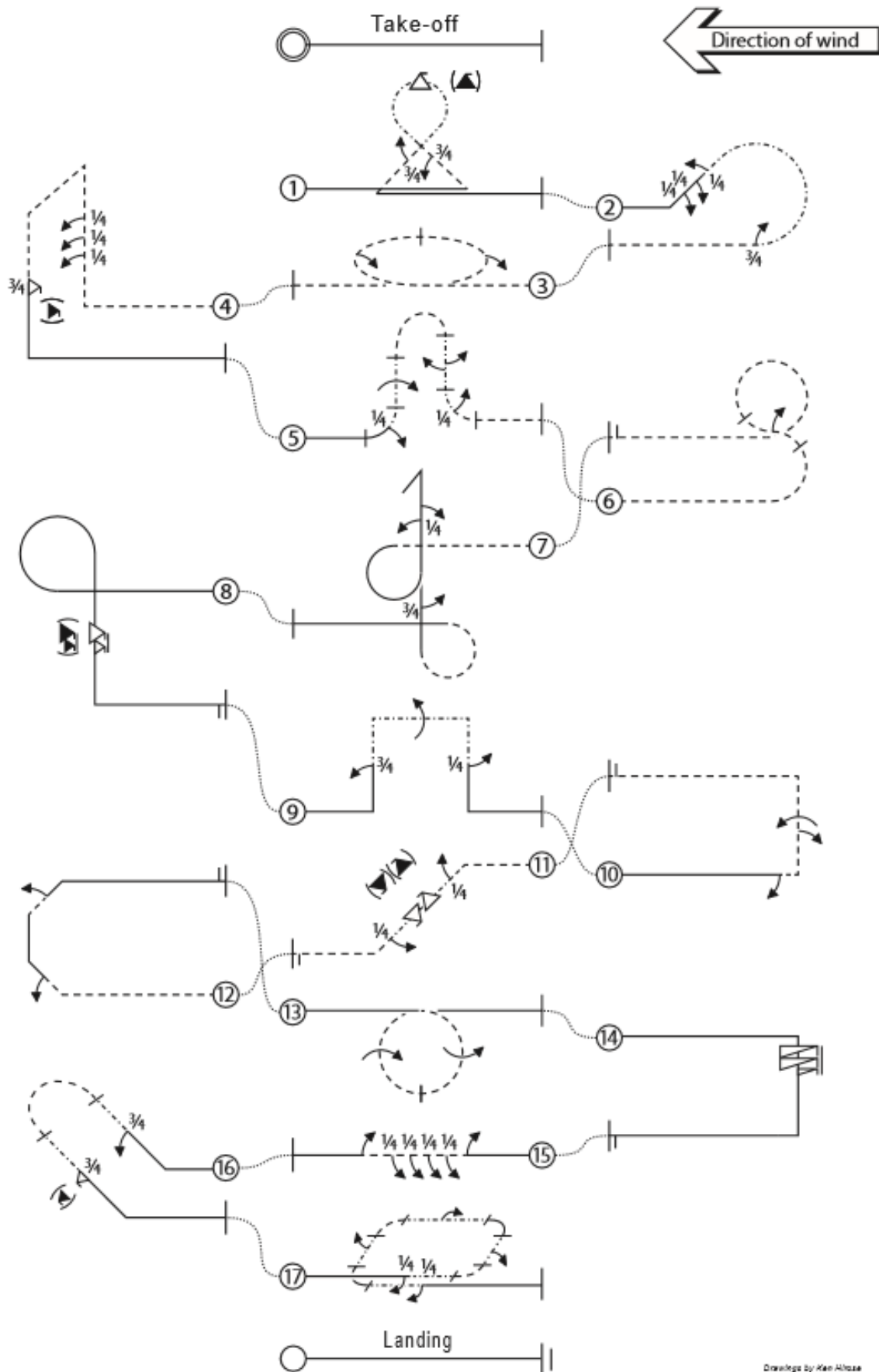

Drawings by Ken Alcock
Aug. 2017

ANNEX 5B

F3 R/C AEROBATIC AIRCRAFT

MANOEUVRE EXECUTION GUIDE

5B.1. PURPOSE

The purpose of the Manoeuvre Execution Guide is to give accurate guidelines for the proper execution of aerobatic manoeuvres to both judges and competitors.

Note that this guide may not be all-inclusive.

5B.2. GENERAL

The flight path of a model aircraft is used to judge the shape of all manoeuvres, and manoeuvres must be entered and exited with straight and level upright or inverted flight of recognisable length. Centre manoeuvres start and finish on the same heading, while turn-around manoeuvres finish on a track 180 degrees from the entry. When appropriate, entry and exit of centre manoeuvres must be at the same altitude, unless specified otherwise. Positioning adjustments in altitude are allowed in turn-around manoeuvres.

5B.3. ACCURATE AND CONSISTENT JUDGING

The most important aspect of consistent judging is for each judge to establish his standard and then maintain that standard throughout the competition. It is advisable for the jury president, in conjunction with the contest director and the championship organiser to hold a conference prior to the start of the competition, in order to discuss judging and make the standards as uniform as possible. This is further augmented by some practice flights which all judges score simultaneously and privately. After these flights, the defects in each manoeuvre should be discussed by all judges and agreement reached about the severity of the defects. Once the contest is started, the individual judge must not alter his standard under any influence.

An accurate standard of judging is also very important. Being a consistent judge, whether high or low, is not good if the scores awarded are not a fair reflection of the manoeuvre performed.

A judge must not, under any circumstances, favour a competitor, or a national team, or a particular flying style, or brand of equipment, or propulsion method. Judges must only look at the lines described in the sky. Conversely, acts of negative bias towards a competitor, or a national team, or a flying style, or brand of equipment, or a propulsion method, must be viewed in a serious light, and corrective action may be necessary.

The performance of the model aircraft or its propulsion device must not be allowed to influence a judge's mark.

5B.4. PRINCIPLES

The principles of judging the performance of a competitor in an R/C Aerobatic competition is based on the perfection with which the competitor's model aircraft executes the aerobatic manoeuvres as described in Annex 5A. The main principles used to judge the degree of perfection are:

1. Geometrical accuracy of the manoeuvre; (weighting approximately 60%).
2. Smoothness and gracefulness of the manoeuvre; (weighting approximately 20%).
3. Positioning of the manoeuvre within the manoeuvring zone; (weighting approximately 10%).
4. Size of the manoeuvre; (weighting approximately 10%).
5. Proportion of the manoeuvre outside of the manoeuvring zone (in addition to the above).

5B.5. DOWNGRADING SYSTEM FOR JUDGING MANOEUVRES

In Annex 5A a description of each manoeuvre is given. With reference to above principles each manoeuvre must be downgraded according to:

1. The type of defect.
2. The severity of the defect.
3. The number of times any one defect occurs, as well as the total number of defects.

Every manoeuvre starts with the mark of 10 points and will be downgraded for each defect during the execution of the manoeuvre in one or multiple 0.5 point steps, depending on the severity of the defect. The remaining points result in the mark for the manoeuvre. A high score should remain only if no substantial, severe or multiple defects are found.

cont/...

Note: A mark resulting from downgrading steps must not be upgraded again in any case, ie. because the manoeuvre contained „something nice“.

5B.6. **ATTITUDE AND FLIGHT PATH**

The flight path of a model aircraft is the trajectory of its centre of gravity. The attitude is the direction of the fuselage centre-line in relation to the flight path.

If not otherwise stated, all judging is based on flight path.

5B.7. **WIND CORRECTION**

All manoeuvres are required to be wind corrected in such a way that the shape of the manoeuvre, as described in Annex 5A, is preserved in the model aircraft's flight path. The exceptions to this criterion are in the snap-rolls, stall turns, and spins, where the model aircraft is in a stalled condition.

5B.8. 1. **GEOMETRICAL ACCURACY OF THE MANOEUVRE**

As a guide for downgrading deviations from the defined manoeuvre geometry, the manoeuvres are divided into their different components: lines, loops, rolls, snap-rolls, horizontal circles, line/loop/roll/horizontal circle combinations, stall turns, and spins.

5B.8.2. **THE 1 POINT PER 15 DEGREE RULE**

This basic rule provides a general guide for downgrading deviations from defined manoeuvre geometry.

1 point must be subtracted for each approximate 15 degrees deviation, but 0.5 points only for half of this. In general, lines must be judged more critically than deviations in yaw or roll.

5B.8.3. **LINES**

All aerobatic manoeuvres are entered and exited by a horizontal line of recognisable length. When no horizontal line is flown between two manoeuvres, the just-completed manoeuvre must be downgraded by 1 point and the upcoming manoeuvre must be downgraded by 1 point.

The total length of a vertical or up/downline, as dictated by the performance of the model aircraft, is not a downgrading criterion.

All lines within a manoeuvre have a start and an end which define their length. They are preceded and followed by part loops. The length of a line should only be graded when a manoeuvre contains more than one line with a given relationship to each other ie as in a square loop. If there is a minor deviation in the relationship then 0.5 point is subtracted, and more points are subtracted for greater deviations.

5B.8.4. **LOOPS**

A loop must have by definition, a constant radius, and must be performed in the vertical plane throughout. It is entered and exited by a well-defined line which, for a complete loop, is horizontal. For a part-loop, however, such lines may be in any other plane of flight as required by the particular manoeuvre.

Loops and part-loops within one manoeuvre must have the same radius. Each occurrence of a minor difference in radius must downgrade the manoeuvre by 0.5 point, while more severe deviations may downgrade it by 1, 1.5, 2 or more points for each occurrence. The first radius of a manoeuvre does not define the radii for the remaining radii of a manoeuvre but it is a starting point. As the manoeuvre progresses, the judge will compare each radius that was just flown to the last radius flown and if there is a difference, then a downgrade will be given based on the severity of the difference.

Every loop or part-loop must be performed without interruption to the circular flight path. Every segmentation must be downgraded by 0.5 or more points.

If the loop is not performed entirely in the vertical plane ie it drifts closer or further from the judges, minor drift must be downgraded by 0.5 point, while more severe drift must be downgraded more.

In three-, four-, six-, and eight-sided loops, the main criteria are that the loop must have the sides at the same lengths/correct angles for the defined number of times, and all part-loops must have the same radius.

5B.8.5. **ROLLS**

Rolls and part-rolls may be performed as individual manoeuvres, or as parts of other manoeuvres. The following applies to all continuous rolls and part-rolls as well as to consecutive continuous rolls and part-rolls:

- a) They must be performed on a constant flight path.
- b) The roll-rate must be constant. Minor variations in roll-rate must be downgraded by 0.5 point, while more severe variations must receive a downgrade of 1 or more points. Slowing down (or speeding up) the roll-rate towards the end of a roll must be downgraded using the 1 point per 15 degree rule.
- c) The start and stop of the rotation must be crisp and well-defined. If a start or stop is badly defined, 0.5 or more points are to be subtracted for each.
- d) In all manoeuvres which have more than one continuous roll, the continuous rolls must have the same roll-rate. In all manoeuvres which have more than one part-roll, the part-rolls must have the same roll rate. Lines between consecutive part-rolls must be short and of equal length. Between consecutive continuous rolls or part-rolls in opposite direction there must be no line. Where there are continuous rolls and part-rolls within one manoeuvre, the roll-rate for the part-rolls does not necessarily have to be the same as the roll-rate for the continuous rolls.

Particular attention has to be paid where the manoeuvre description requires continuous rolls or part-rolls to be performed in opposite directions. For a roll or part-roll performed in the wrong direction, a zero score must be given for the entire manoeuvre.

If, in the manoeuvre description of a roll combination, the roll direction is not specified, then the rolls must go in the same direction.

5B.8.6. **BARREL-ROLLS**

A barrel-roll is a roll, whose flight path goes in a spiral around the virtual hull of a cylinder. Barrel rolls are judged in the same way as axial rolls as far as the constant flight path throughout the roll, the start and stop of the rotation, and the roll direction is concerned.

5B.8.7. **SNAP-ROLLS**

A snap-roll is a rapid auto-rotative roll where the model aircraft is in a stalled attitude, with a continuous high angle of attack.

Snap-rolls are judged in the same way as axial rolls as far as the constant flight path throughout the snap-roll, the start and stop of the rotation, and the roll direction is concerned.

At the start of a snap-roll, the fuselage attitude must show a definite stall-break and attitude separation from the flight path, before the rotation is started, since the model aircraft is supposed to be in a stalled condition throughout the snap-roll. If the stall-break does not occur and the model aircraft barrel-rolls around, the manoeuvre must be severely downgraded (more than 5 points). Similarly, axial rolls disguised as snap-rolls must be severely downgraded (more than 5 points).

Snap-rolls can be flown in both positive and negative attitudes. The attitude (positive or negative) is at the pilot's discretion. If the model aircraft returns to an unstalled condition during the snap-roll, the manoeuvre is downgraded using the 1 point per 15 degree rule.

5B.8.8. **TORQUE-ROLLS**

A torque-roll is a roll, which is executed while the model aircraft is hovering in a vertical attitude and in a fixed position at no flying speed. If the torque-roll is not performed stationary and/or the fixed position is not maintained in all directions, it must be downgraded by 0.5 point or more points, depending on the severity of the defect(s). Absence of a hover must be zeroed. Otherwise torque-rolls are judged the same way as axial rolls as far as the roll rates, the start and stop of the rotation and the roll direction is concerned.

5B.8.9. **HORIZONTAL CIRCLES**

Horizontal circles are performed in a horizontal plane and mostly used as centre manoeuvres. They may be positioned at a higher or lower altitude. Horizontal circles are mainly judged about the circular flight path, constant altitude of the circle, and by constant rates of roll, and integration of the continuous rolls or part-rolls with the circle, if applicable.

The circular flight path should be maintained throughout the manoeuvre and there must be no deviation in altitude. At low level it may be more difficult for judges to determine the roundness of the circle. The 150m distance requirement is waived for horizontal circles, and a downgrade should only be applied if the far side of the circle exceeds approximately 350m. Deviations from geometry should be downgraded as in loops and using the 1 point per 15 degree rule. Depending on the distance from the pilot at the entry, horizontal circles may be performed away from, or towards, the pilot and are at the pilot's discretion.

Other horizontal manoeuvres as combinations of horizontal circles or part-circles with lines etc have to be judged accordingly.

cont/...

5B.8.10. LINE/LOOP/ROLL/HORIZONTAL CIRCLE COMBINATIONS

These are much diversified, but all are combinations of lines, loops, part-loops, continuous rolls, part-rolls, snap-rolls, horizontal circles, and horizontal part-circles. The judging of all these components applies as described above.

Whenever a continuous roll, part-roll, snap roll, or a consecutive combination of these is placed on a line, the length of the line before and after the roll or the combination of consecutive rolls must be equal. 0.5 point is subtracted for a minor difference, and 1 or more points for a major difference. If there is a complete absence of a line before or after the roll, 3 points are subtracted.

Exceptions are all Immelman Turn and Split-S manoeuvres where rolls are always performed immediately before or after or part-loop, which means, the rolls always begin with the start of the lines and stop with the end of the lines. A visible line in-between the two components or rolls and not completely before or after the part-loop, must downgrade the manoeuvre.

Flight paths of continuous rolls or part-rolls that are integrated with loops or horizontal circles should be smooth, continuous, and of constant radius. Where an integrated roll is required, quick-rolling should be downgraded using the 1 point per 15 degree rule.

Particular attention has to be paid where the manoeuvre description requires a continuous roll or part-roll to be performed to the inside or the outside of a horizontal circle. For a continuous roll or part-roll performed in the wrong direction, a zero must be given for the manoeuvre.

5B.8.11. STALL-TURNS

The criteria in this manoeuvre are mainly about lines. The lines must have exactly vertical and horizontal flight paths.

The model aircraft comes to a stop in forward movement and then must pivot around its centre of gravity (CG) in the yaw axis for the manoeuvre to receive a high score. If the model aircraft does not pivot on the CG, but within a radius of a half-wingspan, 1 point is subtracted. For a radius of pivot up to one wingspan, 2 to 3 points are subtracted and if the radius exceeds 1½ wingspans, the manoeuvre must be downgraded 4 to 5 points. A radius of pivot of 2 wingspans or more is considered a wing-over and a zero must be given. If the model aircraft should “torque-off” during the stall turn, a downgrade must be applied using the 1 point per 15 degree rule. If the model aircraft flops forward or backward in a stall turn, a zero score must be given.

If the model aircraft shows a pendulum movement after the pivot, the manoeuvre is downgraded by 1 point. Similarly, if the model aircraft should “skid” or not stop before reaching the stall turn (early application of rudder), the manoeuvre is downgraded by 1 point. Drift of the model aircraft during the stalled condition must be ignored, provided the model aircraft does not drift outside the manoeuvring zone.

5B.8.12. SPINS

All spins are entered and exited with horizontal lines. In order to spin, the model aircraft must be stalled. The entry is flown in a horizontal flight path with the nose-up attitude increasing as the speed decreases. Drift of the model aircraft from the flight path at this point should not be downgraded, since it is in a near-stalled condition. However, severe yawing or weathercocking during the near-stalled condition, should be downgraded by 1 point per 15 degrees. A climbing flight path just prior to the spin must be downgraded, using the 1 point per 15 degree rule. The nose then drops as the model aircraft stalls. Simultaneously as the nose drops, the wing also drops in the direction of the spin. Drift during the rotation of the spin should not be downgraded since the model aircraft is in a stalled condition, provided the model aircraft does not drift outside the manoeuvring zone.

If the model aircraft does not stall or if the model aircraft is snap-rolled or spiral-dived into the spin, the manoeuvre is zeroed. If the model aircraft slides into the spin (is loath to spin), the manoeuvre must be downgraded by using the 1 point per 15 degree rule. Forcing the model aircraft to spin in the opposite direction as the initial rotation must be severely downgraded. Forcing the model aircraft to spin from a high angle of attack with down (or up) elevator, should be downgraded by 4 or 5 points. Judges must carefully observe the stalled attitude, which is not necessarily a complete stop, especially in no-wind conditions. This is no reason for downgrading.

After the defined number of turns, the stop of rotation is judged in the same manner as for a roll, downgraded 1 point per 15 degree deviation of heading. The spin rotation should stop parallel to the flight line. “Unloading”, or stopping the spin rotation early and then applying only aileron to roll the model aircraft to the desired attitude, should be downgraded using the 1 point per 15 degree rule.

A vertical downward line of visible length must be held after the rotation stops. The pull- or push-out is judged like a part-loop and if followed by a part-roll, should be separated by a well-defined

line of straight flight. Different models spin in different attitudes, and the attitude is not to be taken into consideration, as long as the model aircraft is stalled. Any reversals in direction must be immediate, and if the model aircraft returns to an unstalled condition during the spin, the manoeuvre is severely downgraded. The rate of rotation during a reversed spin may be slightly different, without a downgrade, but if the difference is significant, 1 point is subtracted.

5B.9. **SMOOTHNESS AND GRACEFULNESS OF THE MANOEUVRE**

Concerns the harmonic appearance of an entire manoeuvre; i.e. maintaining a constant flight speed throughout the various manoeuvre components, like in climbing and descending sections contributes significantly to smoothness and gracefulness. Radii performed very tight or very loose, though being of equal size within one manoeuvre may be subject for downgrading Smoothness and Gracefulness.

5B.10. **POSITIONING OF THE MANOEUVRE WITHIN THE MANOEUVRING ZONE**

The entire flight must be within the manoeuvring zone to avoid being penalised.

A centre manoeuvre must be flown so that it is centred on the centre line indicated by the centre flag. If the manoeuvre is flown off-centre, it must be downgraded according to the misplacement. This may be in the range of 0.5 to 4 points subtracted. The centre of a centre manoeuvre is in the middle between vertical limits left and right.

Flying so far out as to make evaluation of a manoeuvre difficult should be severely downgraded. The main criterion here is *visibility*. For a large, highly visible model aircraft, a line of flight approximately 175m in front of the pilot may be appropriate, while a smaller less visible model aircraft might have to be flown at say 140 to 150m. Manoeuvres performed on a line greater than approximately 175m in front of the pilot must be downgraded by at least 1 point.. Manoeuvres performed on a line greater than 200m in front of the pilot must be downgraded more severely (in the order of 2 to 3 points).

In general, turn-around manoeuvres are positioning manoeuvres. Therefore, entry and exit altitude need not be the same if the pilot wishes to make an altitude adjustment.

If any part of a manoeuvre is performed beyond the safety line, the manoeuvre will be zeroed. Repeated infringements of the safety line may result in the competitor being asked by the flight line director to terminate the flight, due to safety reasons.

5B.11. **SIZE OF THE MANOEUVRE**

The size of a manoeuvre is scored by its matching size relative to the size of the manoeuvring zone and relative to the size of the other manoeuvres performed throughout a schedule.

5B.12. **PROPORTION OF THE MANOEUVRE OUTSIDE OF THE MANOEUVRING ZONE**

Downgrades for flying a manoeuvre partially out of the zone should be in proportion to the degree of infraction, ie a small part of the manoeuvre (10%) flown past a 60 degree line would call for a downgrade of 1 point, while more of the manoeuvre (30%, 40%, 50% ...) flown past a 60 degree line must be downgraded accordingly by 3, 4, 5... points. If an entire manoeuvre including entry and exit is flown out of the manoeuvring zone, it consequently must be zeroed. However, violations of a 60 degree line that occur near the 150 metre line (ie approximately over a 60 degree flag) should be seen less severely than violations along a line further out and more distant from the judges.

5B.13. **EXAMPLES**

An avalanche is entered in a minor climb, the flight path turns half of 15 degrees to one side after the snap and a wing is half of 15 degrees low during the exit. $10 - 0.5 - 0.5 - 0.5 = 8.5$ points.

Or, an avalanche is entered in a minor climb, the flight path turns 15 degrees to one side after the snap and a wing is 15 degrees low during the exit. $10 - 0.5 - 1 - 1 = 7.5$ points.

Consecutive four $\frac{1}{4}$ rolls are started late and end up minor off-centre and there is no stop/line between the second $\frac{1}{4}$ roll and the third $\frac{1}{4}$ roll. $10 - 0.5 - 6$ (1 point per 15 degrees) = 3.5 points.

Consecutive eight $\frac{1}{8}$ rolls are started late and end up minor off-centre, and there is no stop/line between the first $\frac{1}{8}$ roll and the second $\frac{1}{8}$ roll. $10 - 0.5 - 3 = 6.5$ points.

An Immelmann turn is not well-rounded, the half roll is started before the model aircraft reaches the top of the loop, with the wing 15 degrees low and the flight path of the model aircraft 20 degrees off heading. $10 - 1 - 1 - 1 - 2 = 5$ points.

A snap-roll on a 45 degree downline appears to be nothing more than an axial roll with a wiggle of the tail of the model aircraft. All other components are perfect. $10 - 6 = 4$ points.

cont/...

During a humpty-bump, a snap roll on a vertical downline appears to be a barrel roll, and the exit radius is noticeably smaller in radius than the other two part-loops. $10 - 6 - 1 = 3$ points.

A square loop with half rolls has the first leg climbing 100 degrees. The model aircraft gallops in elevation across the top, stops the vertical downward half roll 15 degrees too early, is corrected, and the last half roll ends up 10 degrees to one side of the centre-line. $10 - 0.5 - 2 - 1 - 0.5 = 6$ points.

On a top hat with $\frac{1}{4}$ rolls, the model aircraft is accidentally rolled in the wrong direction and the horizontal flight is performed upright instead of inverted. $10 - 10 = 0$ points.

In the middle of a double Immelmann, which may be manoeuvre number 12, a competitor experiences an engine cut and the manoeuvre is not completed. $10 - 10 = 0$ points. The rest of the manoeuvres are also awarded zero points.

An otherwise flawless two-turn spin is about 45 degrees off-centre. This must be considered as a severe misplacement. $10 - 4 = 6$ points.

During a stall turn in dead-calm conditions, the flight path of the model aircraft is exactly vertical, but the model aircraft is “skidded” 15% in the upline to ensure a turn. The model aircraft shows a pendulum movement after the stall turn, and the half roll in the downline is performed directly before the part-loop exit. $10 - 1 - 1 - 3 = 5$ points.

A loop with an integrated roll on top has the roll performed rapidly with no attempt by the pilot to integrate the roll with the top 90 degree quadrant of the loop. $10 - 6 = 4$ points.

A half reverse Cuban eight is started too late, and the pilot squeezes the manoeuvre together by flying a 60 degree upline and making no line after the half roll. The manoeuvre still gets about halfway (50%) out of the zone. $10 - 2 - 3 - 5$ (misplacement, going out of the zone) = 0 points.

During an inverted spin entered flawlessly, the model aircraft unstalls and makes the final 90 degree of rotation as a vertical axial roll. $10 - 6 = 4$ points.

A pilot flies flawlessly consecutive eight $\frac{1}{8}$ rolls. $10 - 0 = 10$ points. You will not see too many of these in a competition but a manoeuvre should be awarded a 10 if there are no detectable flaws that would otherwise downgrade it to a 9.5.

A pilot performs a near-perfect split-S, and the only flaw is a minor low wing on exit. $10 - 0.5 = 9.5$ points. In some cases, an error may be so minor and barely visible that a judge may want to consider giving a score of 10, rather than wait for the perfect manoeuvre to arrive.

A pilot performs a manoeuvre other than that stated on the score sheet. $10 - 10 = 0$ points.

After this incident, the pilot performs the rest of the manoeuvres out of sequence, and no manoeuvres correspond to the manoeuvres stated on the score sheet, in the order in which they are listed. All manoeuvres affected in this way score 0 points.

During a figure M, the model aircraft disappears from view behind a low cloud, or produces sun reflections, so that only one stall turn is visible. Every judge scores N/O. The competitor will be awarded a reflight with the entire schedule being judged, but only the mark for the affected manoeuvre used to complete the tabulation.

During an avalanche, a judge fails to notice the snap-roll at the top of the manoeuvre. Score = N/O. The score tabulators will enter the numerical average of the other judges' scores, rounded to the nearest whole number.

After the last flying manoeuvre in a preliminary schedule, an official calls “time”. The competitor lands his aircraft after expiry of the time limit. No penalty.

ANNEX 5G

F3A RADIO CONTROLLED AEROBATIC MODEL AIRCRAFT

UNKNOWN MANOEUVRE SCHEDULES FOR FINAL FLIGHTS

- 5G.1. Unknown manoeuvre schedules shall be used in two of the three final flights for World or Continental Championships and shall be composed by the finalists or by Subcommittee approved computer software. The composition of any unknown schedule shall be completed no less than 12 hours before the commencement of finals flights for unknown schedules.
- 5G.2. If the composition of the unknown manoeuvre schedules is done by the finalists, each finalist nominates in turn an appropriate centre or turn-around manoeuvre from the approved and published list of manoeuvres. This nomination and selection of manoeuvres may be either manual or computer-aided. The order of selection will be determined following the random flight draw with the order repeating until the manoeuvre schedule is complete. The nominated and selected manoeuvres must conform to the following general criteria:
1. The entry of one manoeuvre must be matched to the exit of the previous manoeuvre, for entry altitude, entry attitude (level upright or level inverted flight), size of manoeuvres (wide as in a horizontal eight or narrow as in a stall turn) and direction of flight.
 2. No duplication of manoeuvres.
 3. No duplication of centre manoeuvres from the same manoeuvre group with the exclusion of group 23 manoeuvres.
 4. Spins are entered into the wind.
 5. Minimum one manoeuvre of group 19. or G, and 20. or H, and 22, and 23.
 6. Three manoeuvres of each schedule must have $K = 6$.
 7. Five manoeuvres of each schedule must have $K = 5$.
 8. 17 manoeuvres per unknown schedule:
 - a) 9 centre manoeuvres (5 upwind, 4 downwind).
 - b) 8 turn-around manoeuvres (4 left and 4 right).
 9. The summary of K-factors must be at least 72.

If the composition of the unknown schedules is done by computer software, then criteria 1 - 9 apply accordingly.

- 5G.3. Once an unknown schedule has been composed and checked for correctness it must receive the final approval of the Jury and the contest director. Printed copies, showing the Aresti pictograms and manoeuvre lists, shall then be distributed to team managers, finalists, judges, jury members, and non-finalists who are scheduled to perform warm-up flights. A sufficient number shall be made available by the organisers for spectators.
- 5G.4. After the composition of the unknown schedule, the judges shall receive instructions covering the unknown manoeuvres to ensure that they are fully aware of the sequence of manoeuvres.
- 5G.5. Aresti drawings of the unknown schedules must be provided to finalists and judges.
- 5G.6. Finalists may not attempt practice flights of an unknown schedule between its composition and the finals flights either with a model aircraft or via electronic flight simulator. Evidence of such practice shall be deemed cheating and shall lead to disqualification from the championships. Hand-held stick models are permitted.
- 5G.7. In addition to the warm-up flight for the finals known schedule, at least two warm-up flights must be arranged for the unknown schedule. The unknown warm-up flights may be observed by the finalists and must be judged. Under no circumstances should the flight scores of any warm-up flights be tabulated.
- 5G.8. List of manoeuvres for composition of unknown schedules
- 5G.8.1. **Centre manoeuvres**
(Only one manoeuvre from each number group per schedule)
- 1.1 Rolling loop with one roll (from bottom) (K5)
 - 1.2 Rolling loop with one roll (from bottom) inverted entry (K5)
 - 1.3 Loop with 8-point roll (from bottom) (K5)
 - 1.4 Loop with 8-point roll (from bottom) inverted entry (K5)

- 1.5 Loop with 4-point roll (from bottom) (K5)
- 1.6 Loop with 4-point roll (from bottom) inverted entry (K5)
- 1.7 Knife-edge loop (K6)
- 1.8 Knife-edge loop, inverted entry and exit (K6)
- 1.9 Knife-edge loop from top (K6)
- 1.10 Knife-edge loop from top, inverted entry and exit (K6)
- 1.11 Knife-edge loop with snap roll on top (K6)
- 1.12 Knife-edge loop with snap roll on top, inverted entry and exit (K6)
- 2.1 Two loops with half rolls at top (from bottom) (K3)
- 2.2 Two loops with half rolls at top (from bottom) inverted entry (K4)
- 2.3 Two loops with half rolls at bottom (from top) (K4)
- 2.4 Two loops with half rolls at bottom (from top) inverted entry (K3)
- 2.5 Two loops with full roll first top, half roll second (from bottom) (K4)
- 2.6 Two loops with full roll first top, half roll second, inverted entry (from bottom) (K4)
- 2.7 Two loops with half roll first top, full roll second (from bottom) (K4)
- 2.8 Two loops with half roll first top, full roll second, inverted entry (from bottom) (K4)
- 2.9 Two loops with full roll first bottom, half roll second (from top) (K4)
- 2.10 Two loops with full roll first bottom, half roll second (from top) inverted entry (K4)
- 2.11 Two loops with half roll first bottom, full roll second (from top) (K4)
- 2.12 Two loops with half roll first bottom, full roll second (from top) inverted entry (K4)
- 3.1 Avalanche with full snap (from bottom) (K3)
- 3.2 Avalanche with full snap (from bottom) inverted entry (K3)
- 3.3 Avalanche with 1½ snap (from bottom) (K4)
- 3.4 Avalanche with 1½ snap, inverted entry (from bottom) (K4)
- 3.5 Avalanche with 1 negative snap (from top) (K4)
- 3.6 Avalanche with 1 positive snap (from top) inverted entry (K3)
- 4.1 Triangular loop with full roll (from bottom) (K4)
- 4.2 Triangular loop with full roll (from bottom) inverted entry (K4)
- 4.3 Triangular loop with 2/2pt roll (from bottom) (K4)
- 4.4 Triangular loop with 2/2pt roll (from bottom) inverted entry (K4)
- 4.5 Triangular loop with 2/4pt roll (from bottom) (K4)
- 4.6 Triangular loop with 2/4pt roll (from bottom) inverted entry (K4)
- 4.7 Triangular loop with snap roll (from bottom) (K4)
- 4.8 Triangular loop with snap roll (from bottom) inverted entry (K4)
- 4.9 Triangular loop with 1½ snap roll (from bottom) (K4)
- 4.10 Triangular loop with 1½ snap roll (from bottom) inverted entry (K4)
- 4.11 Triangular loop with 1/2 rolls (from bottom) (K3)
- 4.12 Triangular loop with 1/2 rolls (from bottom) inverted entry (K3)
- 4.13 Triangular loop (base at bottom) with half rolls in 45 degree legs (K3)
- 4.14 Triangular loop (base at bottom) with half rolls in 45 degree legs, inverted entry (K3)
- 4.15 Triangular loop (base at bottom) with 2/4pt rolls in 45 degree legs (K4)
- 4.16 Triangular loop (base at bottom) with 2/4pt rolls in 45 degree legs, inverted entry (K4)
- 4.17 Triangular loop (base at bottom) with 2/2pt rolls in 45 degree legs (K4)
- 4.18 Triangular loop (base at bottom) with 2/2pt rolls in 45 degree legs, inverted entry (K4)
- 4.19 Triangular loop from top (base at top) with half rolls in 45 degree legs (K4)
- 4.20 Triangular loop from top (base at top) with half rolls in 45 degree legs, inverted entry (K4)
- 4.21 Triangular loop from top (base at top) with 2/4pt rolls in 45 degree legs (K4)
- 4.22 Triangular loop from top (base at top) with 2/4pt rolls in 45 degree legs, inverted entry (K4)
- 4.23 Triangular loop from top (base at bottom) with half rolls in 45 degree legs (K4)
- 4.24 Triangular loop from top (base at bottom) with half rolls in 45 degree legs, inverted entry (K4)
- 4.25 Triangular loop from top (base at bottom) with 2/4pt rolls in 45 degree legs (K4)
- 4.26 Triangular loop from top (base at bottom) with 2/4pt rolls in 45 legs, inverted entry (K4)
- 4.27 Triangular loop from top (base at bottom) with 2/4pt roll at bottom (K4)
- 4.28 Triangular loop from top (base at bottom) with 2/4pt roll at bottom, inverted entry (K4)
- 4.29 Triangular loop from top (base at bottom) with full roll (K4)
- 4.30 Triangular loop from top (base at bottom) with full roll, inverted entry (K4)
- 4.31 Knife-edge triangular loop (base at top) (K6)
- 4.32 Knife-edge triangular loop (base at top), inverted entry and exit (K6)
- 4.33 Knife-edge triangular loop (base at top), snap roll on horizontal leg (K6)
- 4.34 Knife-edge triangular loop (base at top), snap roll on horizontal leg, inverted entry and exit (K6)
- 4.35 Knife-edge triangular loop (base at top), roll on horizontal leg (K6)
- 4.36 Knife-edge triangular loop (base at top), roll on horizontal leg, inverted entry and exit (K6)

cont/...

- 5.1 Square loop with half rolls (K5)
- 5.2 Square loop with half rolls, inverted entry (K5)
- 5.3 Square loop with 2/4pt rolls (K5)
- 5.4 Square loop with 2/4pt rolls, inverted entry (K5)
- 5.5 Square loop with full snap over top (K4)
- 5.6 Square loop with full snap over top, inverted entry (K4)
- 5.7 Square loop from top with half rolls (K5)
- 5.8 Square loop from top with half rolls, inverted entry (K5)
- 5.9 Square loop from top with 2/4pt rolls (K5)
- 5.10 Square loop from top with 2/4pt rolls, inverted entry (K5)
- 5.11 Square loop from top with full snap at bottom (K4)
- 5.12 Square loop from top with full snap at bottom, inverted entry (K4)
- 6.1 Square loop on corner (K3)
- 6.2 Square loop on corner, inverted entry (K3)
- 6.3 Square loop on corner with half rolls in legs 1 & 3 (K4)
- 6.4 Square loop on corner with half rolls in legs 1 & 3, inverted entry (K4)
- 6.5 Square loop on corner with full roll in leg 1, half roll in leg 3 (K4)
- 6.6 Square loop on corner with full roll in leg 1, half roll in leg 3, inverted entry (K4)
- 6.7 Square loop on corner with four half rolls (K5)
- 6.8 Square loop on corner with four half rolls, inverted entry (K5)
- 6.9 Square loop on corner from top (K3)
- 6.10 Square loop on corner from top , inverted entry (K3)
- 6.11 Square loop on corner from top with half rolls in legs 1 & 3 (K4)
- 6.12 Square loop on corner from top with half rolls in legs 1 & 3, inverted entry (K4)
- 6.13 Square loop on corner from top with full roll in leg 1, half roll in leg 3 (K4)
- 6.14 Square loop on corner from top with full roll in leg 1, half roll in leg 3, inverted entry (K4)
- 6.15 Square loop on corner from top with four half rolls (K5)
- 6.16 Square loop on corner from top with four half rolls, inverted entry (K5)
- 7.1 Six sided loop (K4)
- 7.2 Six sided loop, inverted entry (K4)
- 7.3 Six sided loop from top (K4)
- 7.4 Six sided loop from top , inverted entry (K4)
- 8.1 Cobra roll with 2/4pt rolls (K3)
- 8.2 Cobra roll with 2/4pt rolls, inverted entry (K3)
- 8.3 Cobra roll with 2/2pt rolls (K3)
- 8.4 Cobra roll with 2/2pt rolls, inverted entry (K3)
- 8.5 Cobra roll from top with half rolls (K3)
- 8.6 Cobra roll from top with half rolls, inverted entry (K3)
- 8.7 Cobra roll from top with 2/4pt rolls (K3)
- 8.8 Cobra roll from top with 2/4pt rolls, inverted entry (K3)
- 8.9 Cobra roll from top with 2/2pt rolls (K3)
- 8.10 Cobra roll from top with 2/2pt rolls, inverted entry (K3)
- 9.1 Golf ball (45 degrees up, 3/4 inside loop, 45 degrees down, pull to level), (K3)
- 9.2 Golf ball, inverted entry (K3)
- 9.3 Golf ball with half rolls (K3)
- 9.4 Golf ball with half rolls, inverted entry (K3)
- 9.5 Golf ball with 2/4pt rolls (K3)
- 9.6 Golf ball with 2/4pt rolls, inverted entry (K3)
- 10.1 Cuban eight with 2/4pt rolls (K3)
- 10.2 Cuban eight with 2/4pt rolls, inverted entry (K3)
- 10.3 Cuban eight with full rolls (K4)
- 10.4 Cuban eight with full rolls, inverted entry (K4)
- 10.5 Reverse cuban eight (from bottom) with 2/4pt rolls (K4)
- 10.6 Reverse cuban eight (from bottom) with 2/4pt rolls, inverted entry (K4)
- 10.7 Reverse cuban eight (from bottom) with full rolls (K4)
- 10.8 Reverse cuban eight (from bottom) with full rolls, inverted entry (K4)
- 10.9 Cuban eight from top with half rolls (K3)
- 10.10 Cuban eight from top with half rolls, inverted entry (K3)
- 10.11 Cuban eight from top with 2/4pt rolls (K4)
- 10.12 Cuban eight from top with 2/4pt rolls, inverted entry (K4)
- 10.13 Cuban eight from top with full rolls (K4)
- 10.14 Cuban eight from top with full rolls, inverted entry (K4)
- 10.15 Reverse cuban eight from top with half rolls (K3)
- 10.16 Reverse cuban eight from top with half rolls, inverted entry (K3)

cont/...

- 10.17 Reverse cuban eight from top with 2/4pt rolls (K4)
- 10.18 Reverse cuban eight from top with 2/4pt rolls, inverted entry (K4)
- 10.19 Reverse cuban eight from top with full rolls (K4)
- 10.20 Reverse cuban eight from top with full rolls, inverted entry (K4)
- 10.21 Knife-edge Cuban eight (K6)
- 10.22 Knife-edge Cuban eight, inverted entry and exit (K6)
- 10.23 Knife-edge Cuban eight with full rolls (K6)
- 10.24 Knife-edge Cuban eight with full rolls, inverted entry and exit (K6)
- 10.25 Knife-edge reverse Cuban eight (K6)
- 10.26 Knife-edge reverse Cuban eight, inverted entry and exit (K6)
- 10.27 Knife-edge reverse Cuban eight with full rolls (K6)
- 10.28 Knife-edge reverse Cuban eight with full rolls, inverted entry and exit (K6)
- 11.1 45 degree down with full snap roll (K3)
- 11.2 45 degree down with full snap roll, inverted entry (K3)
- 11.3 45 degree down with 1½ snap roll (K3)
- 11.4 45 degree down with 1½ snap roll, inverted entry (K3)
- 11.5 45 degree down with two 2/4-point rolls reversed (K4)
- 11.6 45 degree down with two 2/4-point rolls reversed, inverted entry (K4)
- 11.7 45 degree down with two 4/8-point rolls reversed (K4)
- 11.8 45 degree down with two 4/8-point rolls reversed, inverted entry (K4)
- 11.9 45 degree up with 1½ snap roll (K4)
- 11.10 45 degree up with 1½ snap roll, inverted entry (K4)
- 11.11 45 degree up with full snap roll (K3)
- 11.12 45 degree up with full snap roll, inverted entry (K3)
- 11.13 45 degree up with two 2/4-point rolls reversed (K4)
- 11.14 45 degree up with two 2/4-point rolls reversed, inverted entry (K4)
- 11.15 45 degree up with two 4/8-point rolls reversed (K4)
- 11.16 45 degree up with two 4/8-point rolls reversed, inverted entry (K4)
- 12.1 Figure Z with half roll up (K3)
- 12.2 Figure Z with half roll up, inverted entry (K3)
- 12.3 Figure Z with 2/4pt roll up (K4)
- 12.4 Figure Z with 2/4pt roll up, inverted entry (K4)
- 12.5 Figure Z with 2/2pt roll up (K4)
- 12.6 Figure Z with 2/2pt roll up, inverted entry (K4)
- 12.7 Figure Z from top with half roll down (K3)
- 12.8 Figure Z from top with half roll down, inverted entry (K3)
- 12.9 Figure Z from top with 2/4pt roll down (K4)
- 12.10 Figure Z from top with 2/4pt roll down, inverted entry (K4)
- 12.11 Figure Z from top with 2/2pt roll (K4)
- 12.12 Figure Z from top with 2/2pt roll, inverted entry (K4)
- 13.1 Hourglass (K4)
- 13.2 Hourglass, inverted entry (K4)
- 13.3 Hourglass with half rolls up and down (K4)
- 13.4 Hourglass with half rolls up and down, inverted entry (K5)
- 13.5 Hourglass with 2/4pt rolls up and down (K5)
- 13.6 Hourglass with 2/4pt rolls up and down, inverted entry (K5)
- 13.7 Hourglass (middle entry, top first) (K4)
- 13.8 Hourglass (middle entry, top first) inverted entry (K4)
- 13.9 Hourglass (middle entry, top first), half roll down (K4_)
- 13.10 Hourglass (middle entry, top first) half roll down, inverted entry (K4)
- 13.11 Hourglass (middle entry, top first) 2/4pt roll down (K5)
- 13.12 Hourglass (middle entry, top first) 2/4pt roll down, inverted entry (K5)
- 13.13 Hourglass (middle entry, bottom first) (K4)
- 13.14 Hourglass (middle entry, bottom first), inverted entry (K4)
- 13.15 Hourglass (middle entry, bottom first) half roll up (K4)
- 13.16 Hourglass (middle entry, bottom first) half roll up, inverted entry (K4)
- 13.17 Hourglass (middle entry, bottom first) 2/4pt roll up (K4)
- 13.18 Hourglass (middle entry, bottom first) 2/4pt roll up, inverted entry (K4)
- 13.19 Hourglass (top entry) (K4)
- 13.20 Hourglass (top entry), inverted entry (K4)
- 13.21 Hourglass (top entry) with half rolls down and up (K5)
- 13.22 Hourglass (top entry) with half rolls down and up, inverted entry (K5)
- 13.23 Hourglass (top entry) with 2/4pt rolls down and up (K5)
- 13.24 Hourglass (top entry) with 2/4pt rolls down and up, inverted entry (K5)

cont/...

- 14.1 Vertical eight (from bottom) (K3)
- 14.2 Vertical eight (from bottom) inverted entry (K3)
- 14.3 Vertical eight (from bottom) with half rolls (K4)
- 14.4 Vertical eight (from bottom) with half rolls, inverted entry (K4)
- 14.5 Vertical eight (from bottom) with half roll after first half loop (K4)
- 14.6 Vertical eight (from bottom) with half roll after first half loop, inverted entry (K4)
- 14.7 Vertical eight (from middle) (K3)
- 14.8 Vertical eight (from middle) inverted entry (K3)
- 14.9 Vertical eight (from middle) with half roll (K3)
- 14.10 Vertical eight (from middle) with half roll, inverted entry (K3)
- 14.11 Vertical eight (from top) (K3)
- 14.12 Vertical eight (from top) inverted entry (K3)
- 14.13 Vertical eight (from top) with half rolls (K4)
- 14.14 Vertical eight (from top) with half rolls, inverted entry (K4)
- 14.15 Vertical eight (from top) with half roll after first half loop (K4)
- 14.16 Vertical eight (from top) with half roll after first half loop, inverted entry (K4)
- 14.17 Vertical knife-edge eight (K6)
- 14.18 Vertical knife-edge eight, inverted entry and exit (K6)
- 14.19 Vertical knife-edge eight with two half roll (K6)
- 14.20 Vertical knife-edge eight with two half roll, inverted entry and exit (K6)
- 14.21 Vertical knife-edge eight, middle entry and exit, top first (K6)
- 14.22 Vertical knife-edge eight, middle entry and exit, top first, inverted entry & exit (K6)
- 15.1 Square horizontal eight (K5)
- 15.2 Square horizontal eight, inverted entry (K5)
- 15.3 Square horizontal eight (from top) (K5)
- 15.4 Square horizontal eight (from top) inverted entry (K5)
- 15.5 Square vertical eight (from bottom) (K5)
- 15.6 Square vertical eight (from bottom) inverted entry (K5)
- 15.7 Square vertical eight (from bottom) with half rolls (K5)
- 15.8 Square vertical eight (from bottom) with half rolls, inverted entry (K5)
- 15.9 Square vertical eight (from middle) (K5)
- 15.10 Square vertical eight (from middle) inverted entry (K5)
- 15.11 Square vertical eight (from middle) with half roll (K5)
- 15.12 Square vertical eight (from middle) with half roll, inverted entry (K5)
- 15.13 Square vertical eight (from top) (K5)
- 15.14 Square vertical eight (from top) inverted entry (K5)
- 15.15 Square vertical eight (from top) with half rolls (K5)
- 15.16 Square vertical eight (from top) with half rolls, inverted entry (K5)
- 16.1 Figure M with 3/4 rolls (K5)
- 16.2 Figure M with 3/4 rolls, inverted entry (K5)
- 16.3 Figure M with 3/4-point rolls (K5)
- 16.4 Figure M with 3/4-point rolls, inverted entry (K5)
- 16.5 Figure M with 3/4pt rolls up, 1/4 rolls down (K5)
- 16.6 Figure M with 3/4pt rolls up, 1/4 rolls down, inverted entry (K5)
Centre half-loop is always flown negative (inverted)
- 17.1 Top hat with 2/4pt rolls (K4)
- 17.2 Top hat with 2/4pt rolls, inverted entry (K4)
- 17.3 Top hat with 2/2pt rolls (K4)
- 17.4 Top hat with 2/2pt rolls, inverted entry (K4)
- 17.5 Top hat from top with 2/4pt rolls (K4)
- 17.6 Top hat from top with 2/4pt rolls, inverted entry (K4)
- 17.7 Top hat from top with 2/2pt rolls (K4)
- 17.8 Top hat from top with 2/2pt rolls, inverted entry (K4)
- 18.1 Humpty bump, half roll up, 2/4pt roll down (K4)
- 18.2 Humpty bump, 1/2 roll up, 2/4pt roll down, inverted entry (K4)
- 18.3 Humpty bump, 2/4pt roll up, full snap down (K5)
- 18.4 Humpty bump, 2/4pt roll up, full snap down, inverted entry (K5)
- 18.5 Humpty bump from top, half roll down, 2/4pt roll up (K4)
- 18.6 Humpty bump from top, half roll down, 2/4pt roll up, inverted entry (K4)
- 18.7 Humpty bump from top, 2/4pt roll down, full roll up (K4)
- 18.8 Humpty bump from top, 2/4pt roll down, full roll up, inverted entry (K4)
- 19.1 2½ turn spin, inverted exit (K3)
- 19.2 2½ turn spin, inverted entry, upright exit (K3)
- 19.3 2 turn opposite spin (K4)

cont/...

- 19.4 Two turn opposite spin, inverted entry (K4)
- 19.5 Three turn spin (K3)
- 19.6 Three turn spin, inverted entry (K3)
- 19.7 2½ turn spin, half roll exit (K3)
- 19.8 2½ turn spin, half roll exit, inverted entry (K3)
- 20.1 Stall turn 3/4 roll up, 3/4pt roll down (K3)
- 20.2 Stall turn, 3/4 roll up, 3/4pt roll down, inverted entry (K3)
- 20.3 Stall turn 3/4 roll up, 3/4-point roll down, inverted exit (K3)
- 20.4 Stall turn, 3/4 roll up, 1¼ snap roll down (K5)
- 20.5 Stall turn, 3/4 roll up, 1¼ snap roll down, inverted entry (K5)
- 20.6 Stall turn, 3/4 roll up, 1¼ snap roll down, inverted exit (K5)
- 20.7 Stall turn, 3/4pt roll up, 1¼ snap roll down (K5)
- 20.8 Stall turn, 3/4pt roll up, 1¼ snap roll down, inverted entry (K5)
- 20.9 Stall turn, 3/4pt roll up, 1¼ snap roll down, inverted exit (K5)
- 21.1 Double Immelmann with half rolls (K3)
- 21.2 Double Immelmann with half rolls, inverted entry (K3)
- 21.3 Double Immelmann with half roll first, full roll second (K4)
- 21.4 Double Immelmann with half roll first, full roll second, inverted entry (K4)
- 21.5 Double Immelmann with full rolls (K3)
- 21.6 Double Immelmann with full rolls, inverted entry (K3)
- 21.7 Double Immelmann from top, half rolls (K3)
- 21.8 Double Immelmann from top, half rolls, inverted entry (K3)
- 21.9 Double Immelmann from top, half roll first, full roll second (K4)
- 21.10 Double Immelmann from top, half roll first, full roll second, inverted entry (K4)
- 21.11 Double Immelmann from top with full rolls (K4)
- 21.12 Double Immelmann from top with full rolls, inverted entry (K4)
- 22.1 Rolling circle with one roll inside (K5)
- 22.2 Rolling circle with one roll inside, inverted entry (K5)
- 22.3 Rolling circle with one roll outside (K5)
- 22.4 Rolling circle with one roll outside, inverted entry (K5)
- 22.5 Rolling circle with 2 rolls inside (K5)
- 22.6 Rolling circle with 2 rolls inside, inverted entry (K5)
- 22.7 Rolling circle with 2 rolls outside (K5)
- 22.8 Rolling circle with 2 rolls outside, inverted entry (K5)
- 22.9 Rolling circle with 4 rolls inside (K5)
- 22.10 Rolling circle with 4 rolls inside, inverted entry (K5)
- 22.11 Rolling circle with 4 rolls outside (K5)
- 22.12 Rolling circle with 4 rolls outside, inverted entry (K5)

(More than one manoeuvre from the following group is allowed, but not two of the same manoeuvre with only the entry changed)

- 23.1 1½ rolls reversed (K4)
- 23.2 1½ rolls reversed, inverted entry (K4)
- 23.3 Two rolls reversed (K4)
- 23.4 Two rolls reversed, inverted entry (K4)
- 23.5 Four point roll (K4)
- 23.6 Four point roll, inverted entry (K4)
- 23.7 Eight point roll (K4)
- 23.8 Eight point roll, inverted entry (K4)
- 23.9 Two 3/4-point rolls reversed (K4)
- 23.10 Two 3/4-point rolls reversed, inverted entry (K4)
- 23.11 Two 2/2-point rolls reversed (K4)
- 23.12 Two 2/2-point rolls reversed, inverted entry (K4)
- 23.13 Two 2/4-point rolls reversed (K4)
- 23.14 Two 2/4-point rolls reversed, inverted entry (K4)
- 23.15 Slow roll (K3)
- 23.16 Slow roll, inverted entry (K3)
- 23.17 Knife-edge flight (K4)
- 23.18 Knife-edge flight, inverted entry (K4)
- 23.19 Reverse knife-edge flight (K5)
- 23.20 Reverse knife-edge flight, inverted entry (K5)
- 23.21 One horizontal snap roll (K3)
- 23.22 One horizontal snap roll, inverted entry (K4)
- 23.23 Two snap rolls reversed (K5)

cont/...

- 23.24 Two snap rolls reversed, inverted entry (K5)
- 23.25 2/2pt roll, full snap roll opposite (K5)
- 23.26 2/2pt roll, full snap opposite, inverted entry (K5)
- 23.27 2/4pt roll, 1½ snap roll opposite (K5)
- 23.28 2/4pt roll, 1½ snap roll opposite, inverted entry (K5)
- 24.1 Double key: pull into vertical upline, ¾-point roll up, 5/8 knife-edge loop towards the back, ¾ roll down, pull into 45°upline, ¾.roll up, 5/8 knife-edge loop towards the back, ¾-point roll down, pull to exit upright (K6)
- 24.2 Double key: from inverted push into vertical upline, ¾-point roll up, 5/8 knife-edge loop towards the back, ¾ roll down, pull into 45° upline, ¾ roll, 5/8 knife-edge loop towards the back, ¾-point roll down, push to exit inverted (K6)
- 24.3 Double key: pull into a vertical upline, ¾-point roll up, 5/8 knife-edge loop towards the back, ¾ roll down, push into a 45° upline, ¾ roll up, 5/8 knife-edge loop towards the back, ¾-point roll down, pull to exit upright (K6)
- 24.4 Double key: from inverted push into vertical upline, ¾-point roll up, 5/8 knife-edge loop towards the back, ¾ roll down, push into 45° upline, ¾ roll up, 5/8 knife-edge loop towards the back, ¾-point roll down, push to exit inverted (K6)
- 25.1 Horizontal eight with one roll integrated in each loop (K6)
- 25.2 Horizontal eight with one roll integrated in each loop, inverted entry and exit (K6)
- 25.3 Horizontal eight with two rolls integrated in each loop (K6)
- 25.4 Horizontal eight with two rolls integrated in each loop, inverted entry and exit (K6)
- 25.5 Horizontal eight with four rolls integrated in each loop (K6)
- 25.6 Horizontal eight with four rolls integrated in each loop, inverted entry and exit (K6)

5G.8.2. Turnaround manoeuvres

(maximum of two manoeuvres from each group per schedule)

- A.5 Half square loop with 2/4pt roll up (K2)
- A.6 Half square loop with 2/4pt roll up, inverted entry (K2)
- A.7 Half square loop with 2/2pt roll up (K2)
- A.8 Half square loop with 2/2pt roll up, inverted entry (K2)
- A.9 Half square loop with full roll up (K2)
- A.10 Half square loop with full roll up, inverted entry (K2)
- A.15 Half square loop from top, 2/4pt roll down (K2)
- A.16 Half square loop from top, 2/4pt roll down , inverted entry (K2)
- A.17 Half square loop from top, 2/2pt roll down (K2)
- A.18 Half square loop from top, 2/2pt roll down, inverted entry (K2)
- A.19 Half square loop from top, full roll down (K2)
- A.20 Half square loop from top, full roll down, inverted entry (K2)
- A.21 Half square loop from top, full snap down (K3)
- A.22 Half square loop from top, full snap down, inverted entry (K3)
- C.3 Split "S", full roll, from top (K2)
- C.4 Split "S", full roll, from top, inverted entry (K2)
- D.1 Immelmann turn (K2)
- D.2 Immelmann turn, inverted entry (K2)
- D.3 Immelmann turn, full roll (K2)
- D.4 Immelmann turn, full roll, inverted entry (K2)
- D.5 Immelmann Turn from upright with ¼ roll, knife-edge half loop up, ¾ roll, exit upright (K4)
- D.6 Immelmann Turn from upright with ¼ roll, knife-edge half loop up, ¾ roll, exit inverted (K4)
- D.7 Immelmann Turn from upright with ¼ roll, knife-edge half loop down, ¾ roll, exit upright (K4)
- D.8 Immelmann Turn from upright with ¼ roll, knife-edge half loop down, ¾ roll, exit inverted (K4)
- D.9 Immelmann Turn from inverted with ¼ roll, knife-edge half loop up, ¾ roll, exit upright (K4)
- D.10 Immelmann Turn from inverted with ¼ roll, knife-edge half loop up, ¾ roll, exit inverted (K4)
- D.11 Immelmann Turn from inverted with 1/4 roll, knife-edge half loop down , 3/4 roll, exit upright (K4)
- D.12 Immelmann Turn from inverted with 1/4 roll, knife-edge half loop down, 3/4 roll, exit inverted (K4)

cont/...

- E.5 Figure 9 from bottom, 2/4pt roll up (K2)
- E.6 Figure 9 from bottom, 2/4pt roll up, inverted entry (K2)
- E.7 Figure 9 from bottom, 2/2pt roll up (K2)
- E.8 Figure 9 from bottom, 2/2pt roll up, inverted entry (K2)
- E.9 Figure 9 from bottom, full roll up (K2)
- E.10 Figure 9 from bottom, full roll up, inverted entry (K2)
- E.15 Figure 6 from middle (bottom first), 2/4pt roll up (K2)
- E.16 Figure 6 from middle (bottom first), 2/4pt roll up, inverted entry (K2)
- E.17 Figure 6 from middle (bottom first), 2/2pt roll up (K2)
- E.18 Figure 6 from middle (bottom first), 2/2pt roll up, inverted entry (K2)
- E.19 Figure 6 from middle (bottom first), full roll up (K2)
- E.20 Figure 6 from middle (bottom first), full roll up, inverted entry (K2)
- E.25 Figure 9 from middle (top first), 2/4pt roll down (K2)
- E.26 Figure 9 from middle (top first), 2/4pt roll down, inverted entry (K2)
- E.27 Figure 9 from middle (top first), 2/2pt roll down (K2)
- E.28 Figure 9 from middle (top first), 2/2pt roll down, inverted entry (K2)
- E.29 Figure 9 from middle (top first), full roll down (K2)
- E.30 Figure 9 from middle (top first), full roll down, inverted entry (K2)
- E.31 Figure 9 from middle (top first), full snap down (K3)
- E.32 Figure 9 from middle (top first), full snap down, inverted entry (K3)
- E.37 Figure 6 from top, 2/4pt roll down (K2)
- E.38 Figure 6 from top, 2/4pt roll down, inverted entry (K2)
- E.39 Figure 6 from top, 2/2pt roll down (K2)
- E.40 Figure 6 from top, 2/2pt roll down, inverted entry (K2)
- E.41 Figure 6 from top, full roll down (K2)
- E.42 Figure 6 from top, full roll down, inverted entry (K2)
- E.43 Figure 6 from top, full snap down (K3)
- E.44 Figure 6 from top, full snap down, inverted entry (K3)
- E.45 Figure 9 from bottom upright with snap roll up (K3)
- E.46 Figure 9 from bottom inverted with snap roll up (K3)
- E.47 Figure 9 from bottom upright with 1 ½ snap rolls up (K3)
- E.48 Figure 9 from bottom inverted with 1 ½ snap rolls up (K3)
- E.49 Figure 9 from bottom upright with integrated roll in top 180° of loop, exit inverted (K3)
- E.50 Figure 9 from bottom inverted with integrated roll in top 180° of loop, exit upright (K3)
- E.51 Figure 6 from top upright with integrated ½ roll on bottom 180° of loop, exit upright (K3)
- E.52 Figure 6 from top inverted with integrated ½ roll on bottom 180° of loop, exit inverted (K3)
- E.53 Figure 9 from bottom upright with 1/4 roll up, 3/4 knife edge loop, 1/4 roll, exit upright (K4)
- E.54 Figure 9 from bottom upright with 1/4 roll up, 3/4 knife edge loop, 1/4 roll, exit inverted (K4)
- E.55 Figure 9 from bottom inverted with 1/4 roll up, 3/4 knife edge loop, 1/4 roll, exit upright (K4)
- E.56 Figure 9 from bottom inverted with 1/4 roll up, 3/4 knife edge loop, 1/4 roll, exit inverted (K4)
- E.57 Figure 9 from bottom upright with 3 consecutive 1/4 rolls up, 3/4 knife edge loop, 3 consecutive 1/4 rolls, exit upright (K4)
- E.58 Figure 9 from bottom upright with 3 consecutive 1/4 rolls up, 3/4 knife edge loop, 3 consecutive 1/4 rolls, exit inverted (K4)
- E.59 Figure 9 from bottom inverted with 3 consecutive 1/4 rolls up, 3/4 knife edge loop, 3 consecutive 1/4 rolls, exit upright (K4)
- E.60 Figure 9 from bottom inverted with 3 consecutive 1/4 rolls up, 3/4 knife edge loop, 3 consecutive 1/4 rolls, exit inverted (K4)
- E.61 Figure 9 from middle upright with 3 consecutive 1/4 rolls , 3/4 knife edge loop, 3 consecutive 1/4 rolls, exit upright (K4)
- E.62 Figure 9 from middle upright with 3 consecutive 1/4 rolls , 3/4 knife edge loop, 3 consecutive 1/4 rolls, exit inverted (K4)
- E.63 Figure 9 from middle inverted with 3 consecutive 1/4 rolls , 3/4 knife edge loop, 3 consecutive 1/4 rolls, exit upright (K4)
- E.64 Figure 9 from middle inverted with 3 consecutive 1/4 rolls , 3/4 knife edge loop, 3 consecutive 1/4 rolls, exit inverted (K4)
- E.65 Figure 6 from middle upright with 3 consecutive 1/4 rolls , 3/4 knife edge loop, 3 consecutive 1/4 rolls, exit upright (K4)
- E.66 Figure 6 from middle upright with 3 consecutive 1/4 rolls , 3/4 knife edge loop, 3 consecutive 1/4 rolls, exit inverted (K4)
- E.67 Figure 6 from middle inverted with 3 consecutive 1/4 rolls , 3/4 knife edge loop, 3 consecutive 1/4 rolls, exit upright (K4)

- E.68 Figure 6 from middle inverted with 3 consecutive 1/4 rolls , 3/4 knife edge loop, 3 consecutive 1/4 rolls, exit inverted (K4)
- E.69 Figure 6 from top upright with 3/4 snap roll down, 3/4 knife edge loop, 3 consecutive 1/4 rolls, exit upright (K4)
- E.70 Figure 6 from top upright with 3/4 snap roll down, 3/4 knife edge loop, 3 consecutive 1/4 rolls, exit inverted (K4)
- E.71 Figure 6 from top inverted with 3/4 snap roll down, 3/4 knife edge loop, 3 consecutive 1/4 rolls, exit upright (K4)
- E.72 Figure 6 from top inverted with 3/4 snap roll down, 3/4 knife edge loop, 3 consecutive 1/4 rolls, exit inverted (K4)
- F.3 Half cuban eight, 2/4pt roll (K2)
- F.4 Half cuban eight, 2/4pt roll, inverted entry (K2)
- F.5 Half cuban eight, 2/2pt roll (K2)
- F.6 Half cuban eight, 2/2pt roll, inverted entry (K2)
- F.7 Half cuban eight with full roll (K2)
- F.8 Half cuban eight with full roll, inverted entry (K2)
- F.9 Half cuban eight with full snap roll (K3)
- F.10 Half cuban eight with full snap roll, inverted entry (K3)
- F.11 Half cuban eight with 1½ snap roll (K3)
- F.12 Half cuban eight with 1½ snap roll, inverted entry (K3)
- F.15 Half cuban eight from top, 2/4pt roll up (K2)
- F.16 Half cuban eight from top, 2/4pt roll up, inverted entry (K2)
- F.17 Half cuban eight from top, 2/2pt roll up (K2)
- F.18 Half cuban eight from top, 2/2pt roll up, inverted entry (K2)
- F.19 Half cuban eight from top, full roll up (K2)
- F.22 Half reverse cuban eight, inverted entry (K2)
- F.23 Half reverse cuban eight, 2/4pt roll (K2)
- F.24 Half reverse cuban eight, 2/4pt roll, inverted entry (K2)
- F.25 Half reverse cuban eight, 2/2pt roll (K2)
- F.26 Half reverse cuban eight, 2/2pt roll, inverted entry (K2)
- F.27 Half reverse cuban eight with full roll (K2)
- F.28 Half reverse cuban eight with full roll, inverted entry (K2)
- F.29 Half reverse cuban eight with full snap roll (K3)
- F.30 Half reverse cuban eight with full snap roll, inverted entry (K3)
- F.31 Half reverse cuban eight with 1 1/2 snap roll (K3)
- F.32 Half reverse cuban eight with 1 1/2 snap roll, inverted entry (K3)
- F.35 Half reverse cuban eight from top, 2/4pt roll down (K2)
- F.36 Half reverse cuban eight from top, 2/4pt roll down, inverted entry (K2)
- F.37 Half reverse cuban eight from top, 2/2pt roll down (K2)
- F.38 Half reverse cuban eight from top, 2/2pt roll down, inverted entry (K2)
- F.39 Half reverse cuban eight from top, full roll down (K2)
- F.40 Half reverse cuban eight from top, full roll down, inverted entry (K2)
- F.41 Half Cuban Eight from upright up with ½ roll integrated in first 180° of loop, exit upright (K3)
- F.42 Half Cuban Eight from inverted up with ½ roll integrated in first 180° of loop, exit inverted (K3)
- F.43 Half Cuban Eight from upright up with roll integrated in first 180° of loop, exit inverted (K4)
- F.44 Half Cuban Eight from inverted up with roll integrated in first 180° of loop, exit upright (K4)
- F.45 Half Cuban Eight from upright down with ½ roll integrated in first 180° of loop, exit upright (K3)
- F.46 Half Cuban Eight from inverted down with ½ roll integrated in first 180° of loop, exit inverted (K3)
- F.47 Half Cuban Eight from upright down with roll integrated in first 180° of loop, exit inverted (K4)
- F.48 Half Cuban Eight from inverted down with roll integrated in first 180° of loop, exit upright (K4)
- F.49 Half cuban eight from upright with 3 consecutive 1/4 rolls, 5/8 knife edge loop, 3/4 roll, exit upright (K4)
- F.50 Half cuban eight from upright with 3 consecutive 1/4 rolls, 5/8 knife edge loop, 3/4 roll, exit inverted (K4)
- F.51 Half cuban eight from inverted with 3 consecutive 1/4 rolls, 5/8 knife edge loop, 3/4 roll, exit upright (K4)
- F.52 Half cuban eight from inverted with 3 consecutive 1/4 rolls, 5/8 knife edge loop, 3/4 roll, exit inverted (K4)

- F.53 Half reverse cuban eight from upright with 3 consecutive 1/4 rolls, 5/8 knife edge loop, 3/4 roll, exit upright (K4)
- F.54 Half reverse cuban eight from upright with 3 consecutive 1/4 rolls, 5/8 knife edge loop, 3/4 roll, exit inverted (K4)
- F.55 Half reverse cuban eight from inverted with 3 consecutive 1/4 rolls, 5/8 knife edge loop, 3/4 roll, exit upright (K4)
- F.56 Half reverse cuban eight from inverted with 3 consecutive 1/4 rolls, 5/8 knife edge loop, 3/4 roll, exit inverted (K4)
- F.57 Half cuban eight from top upright with 3 consecutive 1/4 rolls, 5/8 knife edge loop, 3/4 roll, exit upright (K4)
- F.58 Half cuban eight from top upright with 3 consecutive 1/4 rolls, 5/8 knife edge loop, 3/4 roll, exit inverted (K4)
- F.59 Half cuban eight from top inverted with 3 consecutive 1/4 rolls, 5/8 knife edge loop, 3/4 roll, exit upright (K4)
- F.60 Half cuban eight from top inverted with 3 consecutive 1/4 rolls, 5/8 knife edge loop, 3/4 roll, exit inverted (K4)
- F.61 Half reverse cuban eight from top upright with 3 consecutive 1/4 rolls, 5/8 knife edge loop, 3/4 roll, exit upright (K4)
- F.62 Half reverse cuban eight from top upright with 3 consecutive 1/4 rolls, 5/8 knife edge loop, 3/4 roll, exit inverted (K4)
- F.63 Half reverse cuban eight from top inverted with 3 consecutive 1/4 rolls, 5/8 knife edge loop, 3/4 roll, exit upright (K4)
- F.64 Half reverse cuban eight from top inverted with 3 consecutive 1/4 rolls, 5/8 knife edge loop, 3/4 roll, exit inverted (K4)
- G.1 Two turn spin (K2)
- G.2 Two turn spin, inverted entry (K2)
- G.3 2 1/2 turn spin (K2)
- G.4 2 1/2 turn spin, inverted entry (K2)
- H.3 Stall turn, half roll up, 2/4pt roll down (K2)
- H.4 Stall turn, half roll up, 2/4pt roll down, inverted entry (K2)
- H.5 Stall turn, full roll up, half roll down (K2)
- H.6 Stall turn, full roll up, half roll down, inverted entry (K2)
- H.7 Stall turn, 2/4pt roll up, half roll down (K2)
- H.8 Stall turn, 2/4pt roll up, half roll down, inverted entry (K2)
- H.9 Stall turn, 2/2pt roll up, 2/4pt roll down (K2)
- H.10 Stall turn, 2/2pt roll up, 2/4pt roll down, inverted entry (K2)
- H.11 Stall turn, half roll up, full snap down (K4)
- H.12 Stall turn, half roll up, full snap down, inverted entry (K4)
- H.13 Stall turn, 3/4pt roll up, 1/4 roll down (K3)
- H.14 Stall turn, 3/4pt roll up 1/4 roll down, inverted entry (K3)
- H.15 Stall turn, 3/4 roll up, 1¼ snap down (K4)
- H.16 Stall turn 3/4 roll up, 1¼ snap down, inverted entry (K4)
- J.1 Top hat, 3/4 roll up, 1/4 roll down (K2)
- J.2 Top hat, 3/4 roll up, 1/4 roll down, inverted entry (K2)
- J.3 Top hat, 3/4pt roll up, 3/4 roll down (K2)
- J.4 Top hat, 3/4pt roll up, 3/4 roll down, inverted entry (K2)
- J.5 Top hat, 3/4pt roll up, 3/4-point roll down, inverted exit (K2)
- J.6 Top hat, 3/4pt roll up, 3/4pt roll down, inverted entry and exit (K2)
- J.7 Top hat, 1/4 roll up, 1/4 roll down (K2)
- J.8 Top hat, 1/4 roll up, 1/4 roll down, inverted entry (K2)
- J.9 Top hat, 1/4 roll up, 1/4 roll down, inverted exit (K2)
- J.10 Top hat, 1/4 roll up, 1/4 roll down, inverted entry and exit (K2)
- J.11 Top hat from top, 3/4 roll down, 3/4pt roll up (K3)
- J.12 Top hat from top, 3/4 roll down, 3/4pt roll up, inverted entry (K3)
- J.13 Top hat from top, 3/4 roll down, 1/4 roll up (K2)
- J.14 Top hat from top, 3/4 roll down, 1/4 roll up, inverted entry (K2)
- J.15 Top hat from top, 1/4 roll down, 3/4pt roll up (K2)
- J.16 Top hat from top, 1/4 roll down, 3/4pt roll up, inverted entry (K2) 1¼
Horizontal (cross-box) flight is always flown inverted.
- J.17 Top Hat, from upright, three consecutive ¼ rolls up, 1 ¾ snap roll down, exit upright (K4)
- J.18 Top Hat, from upright, three consecutive ¼ rolls up, 1 ¾ snap roll down, exit inverted (K4)
- J.19 Top Hat, from inverted, three consecutive ¼ rolls up, 1 ¾ snap roll down, exit upright (K4)
- J.20 Top Hat, from inverted, three consecutive ¼ rolls up, 1 ¾ snap roll down, exit inverted (K4)

cont/...

- J.22 Top Hat, from top upright, $\frac{3}{4}$ roll down, 1 $\frac{3}{4}$ snap roll up, exit upright (K4)
- J.23 Top Hat, from top upright, $\frac{3}{4}$ roll down, 1 $\frac{3}{4}$ snap roll up, exit inverted (K4)
- J.24 Top Hat, from top inverted, $\frac{3}{4}$ roll down, 1 $\frac{3}{4}$ snap roll up, exit upright (K4)
- J.25 Top Hat, from top inverted, $\frac{3}{4}$ roll down, 1 $\frac{3}{4}$ snap roll up, exit inverted (K4)
- J.26 Top Hat, from upright, $\frac{3}{4}$ roll up, 1 $\frac{1}{4}$ snap roll down, exit upright (K4)
- J.27 Top Hat, from upright, $\frac{3}{4}$ roll up, 1 $\frac{1}{4}$ snap roll down, exit inverted (K4)
- J.28 Top Hat, from inverted, $\frac{3}{4}$ roll up, 1 $\frac{1}{4}$ snap roll down, exit upright (K4)
- J.29 Top Hat, from inverted, $\frac{3}{4}$ roll up, 1 $\frac{1}{4}$ snap roll down, exit inverted (K4)
- J.30 Top Hat, from top upright, $\frac{3}{4}$ roll down, 1 $\frac{1}{4}$ snap roll up, exit upright (K4)
- J.31 Top Hat, from top upright, $\frac{3}{4}$ roll down, 1 $\frac{1}{4}$ snap roll up, exit inverted (K4)
- J.32 Top Hat, from top inverted, $\frac{3}{4}$ roll down, 1 $\frac{1}{4}$ snap roll up, exit upright (K4)
- J.33 Top Hat, from top inverted, $\frac{3}{4}$ roll down, 1 $\frac{1}{4}$ snap roll up, exit inverted (K4)
- J.34 Top Hat, from upright, $\frac{1}{2}$ roll up, snap roll down, exit upright (K3)
- J.35 Top Hat, from inverted, $\frac{1}{2}$ roll up, snap roll down, exit inverted (K3)
- J.36 Top Hat, from top upright, $\frac{1}{2}$ roll down, snap roll up, exit upright (K3)
- J.37 Top Hat, from top inverted, $\frac{1}{2}$ roll down, snap roll up, exit inverted (K3)
- J.38 Top Hat from top upright with 2 $\frac{1}{4}$ turn Spin entry, $\frac{3}{4}$ Roll up, exit upright (K4)
- J.39 Top Hat from top upright with 2 $\frac{1}{4}$ turn Spin entry, $\frac{3}{4}$ Roll up, exit inverted (K4)
- J.40 Top Hat from top inverted with 2 $\frac{1}{4}$ turn Spin entry, $\frac{3}{4}$ Roll up, exit upright (K4)
- J.41 Top Hat from top inverted with 2 $\frac{1}{4}$ turn Spin entry, $\frac{3}{4}$ Roll up, exit inverted (K4)
- J.42 Top Hat from top upright with 2 turn Spin entry, Full Roll up, exit inverted (K3)
- J.43 Top Hat from top inverted with 2 turn Spin entry, Full Roll up, exit upright (K3)
- J.44 Top Hat from top upright with 2 turn Spin entry, four consecutive $\frac{1}{4}$ rolls up, exit inverted (K3)
- J.45 Top Hat from top inverted with 2 turn Spin entry, four consecutive $\frac{1}{4}$ rolls up, exit upright (K3)
- K.1 45 degree up, 2/4pt roll, half loop (inside or outside), full roll down (K3)
- K.2 45 degree up, 2/4pt roll, half loop (inside or outside), full roll down, inverted entry (K3)
- K.3 45 degree up, 2/2pt roll, half loop (inside or outside), 2/4pt roll down (K3)
- K.4 45 degree up, 2/2pt roll, half loop (inside or outside), 2/4pt roll down, inverted entry (K3)
- K.5 45 degree up, full roll, half loop (inside or outside), 2/4pt roll down (K3)
- K.6 45 degree up, full roll, half loop (inside or outside), 2/4pt roll down, inverted entry (K3)
- K.7 45 degree up, 2/2pt roll, half loop (inside or outside), full snap roll down (K4)
- K.8 45 degree up, 2/2pt roll, half loop (inside or outside), full snap roll down, inverted entry (K4)
- K.9 45° up-line from upright, $\frac{1}{4}$ roll, knife-edge half loop (up or down), three consecutive $\frac{1}{4}$ rolls down, exit upright (K4)
- K.10 45° up-line from upright, $\frac{1}{4}$ roll, knife-edge half loop (up or down), three consecutive $\frac{1}{4}$ rolls down, exit inverted (K4)
- K.11 45° up-line from inverted, $\frac{1}{4}$ roll, knife-edge half loop (up or down), three consecutive $\frac{1}{4}$ rolls down, exit upright (K4)
- K.12 45° up-line from inverted, $\frac{1}{4}$ roll, knife-edge half loop (up or down), three consecutive $\frac{1}{4}$ rolls down, exit inverted (K4)
- K.13. 45° up-line from upright, $\frac{3}{4}$ roll, knife-edge half loop (up or down), three consecutive $\frac{1}{4}$ rolls down, exit upright (K4)
- K.14. 45° up-line from upright, $\frac{3}{4}$ roll, knife-edge half loop (up or down), three consecutive $\frac{1}{4}$ rolls down, exit inverted (K4)
- K.15. 45° up-line from inverted, $\frac{3}{4}$ roll, knife-edge half loop (up or down), three consecutive $\frac{1}{4}$ rolls down, exit upright (K4)
- K.16. 45° up-line from inverted, $\frac{3}{4}$ roll, knife-edge half loop (up or down), three consecutive $\frac{1}{4}$ rolls down, exit inverted (K4)
- K.17. 45° up-line from upright, three consecutive $\frac{1}{4}$ rolls, knife-edge half loop (up or down), $\frac{1}{4}$ roll down, exit upright (K4)
- K.18. 45° up-line from upright, three consecutive $\frac{1}{4}$ rolls, knife-edge half loop (up or down), $\frac{1}{4}$ roll down, exit inverted (K4)
- K.19. 45° up-line from inverted, three consecutive $\frac{1}{4}$ rolls, knife-edge half loop (up or down), $\frac{1}{4}$ roll down, exit upright (K4)
- K.20. 45° up-line from inverted, three consecutive $\frac{1}{4}$ rolls, knife-edge half loop (up or down), $\frac{1}{4}$ roll down, exit inverted (K4)

cont/...

- K.21. 45° up-line from upright, three consecutive $\frac{1}{4}$ rolls, knife-edge half loop (up or down), $\frac{3}{4}$ roll down, exit upright (K4)
- K.22. 45° up-line from upright, three consecutive $\frac{1}{4}$ rolls, knife-edge half loop (up or down), $\frac{3}{4}$ roll down, exit inverted (K4)
- K.23. 45° up-line from inverted, three consecutive $\frac{1}{4}$ rolls, knife-edge half loop (up or down), $\frac{3}{4}$ roll down, exit upright (K4)
- K.24. 45° up-line from inverted, three consecutive $\frac{1}{4}$ rolls, knife-edge half loop (up or down), $\frac{3}{4}$ roll down, exit inverted (K4)
- K.25. 45° up-line from upright, $\frac{1}{4}$ roll, knife-edge half loop (up or down), $\frac{3}{4}$ snap roll down, exit upright (K5)
- K.26. 45° up-line from upright, $\frac{1}{4}$ roll, knife-edge half loop (up or down), $\frac{3}{4}$ snap roll down, exit inverted (K5)
- K.27. 45° up-line from inverted, $\frac{1}{4}$ roll, knife-edge half loop (up or down), $\frac{3}{4}$ snap roll down, exit upright (K5)
- K.28. 45° up-line from inverted, $\frac{1}{4}$ roll, knife-edge half loop (up or down), $\frac{3}{4}$ snap roll down, exit inverted (K5)
- K.29. 45° up-line from upright, $\frac{3}{4}$ roll, knife-edge half loop (up or down), $\frac{3}{4}$ snap roll down, exit upright (K5)
- K.30. 45° up-line from upright, $\frac{3}{4}$ roll, knife-edge half loop (up or down), $\frac{3}{4}$ snap roll down, exit inverted (K5)
- K.31. 45° up-line from inverted, $\frac{3}{4}$ roll, knife-edge half loop (up or down), $\frac{3}{4}$ snap roll down, exit upright (K5)
- K.32. 45° up-line from inverted, $\frac{3}{4}$ roll, knife-edge half loop (up or down), $\frac{3}{4}$ snap roll down, exit inverted (K5)
- L.1 Humpty bump (pull, pull, push) half roll up, 2/4pt roll down (K3)
- L.2 Humpty bump (push, push, pull) half roll up, 2/4pt roll down, inverted entry (K3)
- L.3 Humpty bump (pull, pull, pull) half roll up, 2/2pt roll down (K3)
- L.4 Humpty bump (push, push, push) half roll up, 2/2pt roll down, inverted entry (K3)
- L.5 Humpty bump (pull, pull, push) 2/4pt roll up, half roll down (K3)
- L.6 Humpty bump (push, push, pull) 2/4pt roll up, half roll down, inverted entry (K3)
- L.7 Humpty bump (pull, pull, push, or pull, push, push) 1/4 roll up, 3/4 roll down (K3)
- L.8 Humpty bump (push, pull, pull, or push, push, pull) 1/4 roll up, 3/4 roll down inverted entry (K3)
- L.9 Humpty bump (pull, pull, pull) 3/4pt roll up, 1/4 roll down (K3)
- L.10 Humpty bump (push, pull, pull) 3/4pt roll up, 1/4 roll down, inverted entry (K3)
- L.11 Humpty bump with roll options, (half roll up or 1/4 roll up and down) (K2)
- L.12 Humpty bump with roll options, (half roll up or 1/4 roll up and down) inverted entry (K2)
- M.1 Humpty bump from top, half roll down (push, push, push) (K3)
- M.2 Humpty bump from top, half roll down, inverted entry (pull, pull, pull) (K2)
- M.3 Humpty bump from top, 2/4pt roll down, half roll up (push, push, pull) (K3)
- M.4 Humpty bump from top, 2/4pt roll down, half roll up, inverted entry (pull, pull, push) (K3)
- M.5 Humpty bump from top, 2/4pt roll down, 2/2pt roll up (push, push, push) (K3)
- M.6 Humpty bump from top, 2/4pt roll down, 2/2pt roll up, inverted entry (pull, pull, pull) (K3)
- M.7 Humpty bump from top, 1/4 roll down, 3/4 roll up (push, push, push) (K3)
- M.8 Humpty bump from top, 1/4 roll down, 3/4 roll up, inverted entry (pull, push, push) (K3)
- M.9 Humpty bump from top, 1/4 roll down, 3/4 roll up, inverted entry and exit (pull, push, pull) (K3)
- M.10 Humpty bump from top, 1/4 roll down, 3/4 roll up, inverted exit (push, push, pull) (K3)
- N.1 Half Square Loop on Corner from upright up with $\frac{1}{4}$ roll on first leg, $\frac{1}{4}$ roll on second leg, exit upright (K3)
- N.2 Half Square Loop on Corner from upright up with $\frac{1}{4}$ roll on first leg, $\frac{1}{4}$ roll on second leg, exit inverted (K3)
- N.3 Half Square Loop on Corner from inverted up with $\frac{1}{4}$ roll on first leg, $\frac{1}{4}$ roll on second leg, exit upright (K3)
- N.4 Half Square Loop on Corner from inverted up with $\frac{1}{4}$ roll on first leg, $\frac{1}{4}$ roll on second leg, exit inverted (K3)
- N.5 Half Square Loop on Corner from upright down with $\frac{1}{4}$ roll on first leg, $\frac{1}{4}$ roll on second leg, exit upright (K3)
- N.6 Half Square Loop on Corner from upright down with $\frac{1}{4}$ roll on first leg, $\frac{1}{4}$ roll on second leg, exit inverted (K3)
- N.7 Half Square Loop on Corner from inverted down with $\frac{1}{4}$ roll on first leg, $\frac{1}{4}$ roll on second leg, exit upright (K3)
- N.8 Half Square Loop on Corner from inverted down with $\frac{1}{4}$ roll on first leg, $\frac{1}{4}$ roll on second leg, exit inverted (K3)

- N.9 Half Square Loop on Corner from upright up with snap roll on first leg, snap roll on second leg, exit inverted (K5)
- N.10 Half Square Loop on Corner from inverted up with snap roll on first leg, snap roll on second leg, exit upright (K5)
- N.11 Half Square Loop on Corner from upright down with snap roll on first leg, snap roll on second leg, exit inverted (K5)
- N.12 Half Square Loop on Corner from inverted down with snap roll on first leg, snap roll on second leg, exit upright (K5)
- N.13 Half Square Loop on Corner from upright up with $1\frac{1}{4}$ snap roll on first leg, $\frac{3}{4}$ roll on second leg, exit upright (K5)
- N.14 Half Square Loop on Corner from upright up with $1\frac{1}{4}$ snap roll on first leg, $\frac{3}{4}$ roll on second leg, exit inverted (K5)
- N.15 Half Square Loop on Corner from inverted up with $1\frac{1}{4}$ roll on first leg, $\frac{3}{4}$ roll on second leg, exit upright (K5)
- N.16 Half Square Loop on Corner from inverted up with $1\frac{1}{4}$ roll on first leg, $\frac{3}{4}$ roll on second leg, exit inverted (K5)
- N.17 Half Square Loop on Corner from upright down with $1\frac{1}{4}$ roll on first leg, $\frac{3}{4}$ roll on second leg, exit upright (K5)
- N.18 Half Square Loop on Corner from upright down with $1\frac{1}{4}$ roll on first leg, $\frac{3}{4}$ roll on second leg, exit inverted (K5)
- N.19 Half Square Loop on Corner from inverted down with $1\frac{1}{4}$ roll on first leg, $\frac{3}{4}$ roll on second leg, exit upright (K5)
- N.20 Half Square Loop on Corner from inverted down with $1\frac{1}{4}$ roll on first leg, $\frac{3}{4}$ roll on second leg, exit inverted (K5)
- N.21 Half Square Loop on Corner from upright up with $1\frac{1}{4}$ snap roll on first leg, $1\frac{1}{4}$ snap roll on second leg, exit upright (K5)
- N.22 Half Square Loop on Corner from upright up with $1\frac{1}{4}$ snap roll on first leg, $1\frac{1}{4}$ snap roll on second leg, exit inverted (K5)
- N.23 Half Square Loop on Corner from inverted up with $1\frac{1}{4}$ roll on first leg, $1\frac{1}{4}$ snap roll on second leg, exit upright (K5)
- N.24 Half Square Loop on Corner from inverted up with $1\frac{1}{4}$ roll on first leg, $1\frac{1}{4}$ snap roll on second leg, exit inverted (K5)
- N.25 Half Square Loop on Corner from upright down with $1\frac{1}{4}$ roll on first leg, $1\frac{1}{4}$ snap roll on second leg, exit upright (K5)
- N.26 Half Square Loop on Corner from upright down with $1\frac{1}{4}$ roll on first leg, $1\frac{1}{4}$ snap roll on second leg, exit inverted (K5)
- N.27 Half Square Loop on Corner from inverted down with $1\frac{1}{4}$ roll on first leg, $1\frac{1}{4}$ snap roll on second leg, exit upright (K5)
- N.28 Half Square Loop on Corner from inverted down with $1\frac{1}{4}$ roll on first leg, $1\frac{1}{4}$ snap roll on second leg, exit inverted (K5)

PAGE DELIBERATELY LEFT BLANK

5.10. CLASS F3M – RADIO CONTROLLED LARGE AEROBATIC AIRCRAFT**Introduction**

R/C Large Aerobatic Aircraft F3M is a competition class inspired by CIVA Unlimited full scale aerobatics from the FAI.

The rules which follow, contain material sourced from the *AMA Scale Aerobatics Rulebook (2015)* and the *Known and Unknown Sequences*. Permission has been granted to use this material by the International Miniature Aerobatic Club (IMAC).

5.10.1. Definition of a Radio Controlled Large Aerobatic Aircraft

A model aircraft, but not a helicopter, which is aerodynamically manoeuvred by control surface(s) in attitude, direction, and altitude by a pilot on the ground using radio control.

The model aircraft must be a scaled-down version of a full-size aerobatic aircraft. The general outlines of the model shall approximate the full size outlines of the subject aircraft. Exact scale is not required.

General characteristics of Radio Controlled Large Aerobatic Aircraft shall be verified in processing procedures as per FAI Sporting Code, Section 4, Volume CGR, for each participating model aircraft prior to a competition

5.10.2. General Characteristics of R/C Large Aerobatic Aircraft

Minimum overall span for monoplanes	2.1 m
Minimum overall span for biplanes	1.8 m
Maximum take off weight (with fuel and enhancers devices)	25 kg

- a) A tolerance of 1% will be allowed for possible inconsistencies in measurement instruments for size, weight, and voltage unless otherwise stated.
- b) Propulsion device limitations: Any suitable propulsion device may be used. Propulsion devices that are not permitted are those requiring solid expendable propellants, gaseous fuels (at room temperature and atmospheric pressure), or liquefied gaseous fuels.
- c) Only one propeller per aircraft is allowed. If the aircraft is utilising an internal combustion engine, only one engine is allowed. If the aircraft is utilising electric motors, more than one electric motor may be used.
- d) The propulsion device(s) must automatically shut-off or fully idle at the moment an R/C signal failure occurs.
- e) Radio equipment shall be of the open loop type (i.e. no electronic feedback from the model aircraft to the ground except for the stipulations in CIAM General Rules C.16.2.3). Auto-pilot control utilising inertia, gravity or any type of terrestrial reference is prohibited. Automatic control sequencing (pre-programming) or automatic control timing devices are prohibited.

Example:

Permitted:

1. Control rate devices that are manually switched by the pilot.
2. Any type of button or lever, switches, or dials control that are initiated or activated and terminated by the competitor.
3. Manually operated switches or programmable options to couple and mix control functions.

cont/...

Not permitted:

1. Snap roll buttons with automatic timing mode.
2. Pre-programming devices to automatically perform series of commands.
3. Auto-pilots or gyros for automatic wing levelling or other stabilisation of the model aircraft.
4. Automatic flight path guidance.
5. Propeller pitch change with automatic timing mode.
6. Any type of voice recognition system.
7. Any type of learning function involving manoeuvre to manoeuvre or flight to flight analysis.

Note: A Spread Spectrum technology receiver that transmits information back to the pilot-operated transmitter, is not considered to be a “device for the transmission of information from the model aircraft to the competitor”, provided that the only information that is transmitted is for the safe operation of the model aircraft.

5.10.3. Technical verifications

1. Proof of scale:

- a) To prove that the general outlines of the model approximate the full size outlines of the subject aircraft, the competitor or his helper must submit, before the start of the competition, an accurate three-view drawing of the subject aircraft and some photos of the full size aerobatic aircraft in relation to the three-view drawing.
- b) The model shall be judged for likeness at a distance of approximately 3 metres.
- c) General outlines of the model should approximate the full size subject aerobatic aircraft.
- d) The area of control surfaces compared to fixed surfaces will not be considered.
- e) Example: only the general outline of the wing, stabilizer and fin will be considered, not the ailerons, elevator, or rudder, but the concept of moving surfaces must be the same as on the subject aircraft. (Aileron may be in two parts, moving part of the fin for aerodynamic balance, etc. Trim tabs or winglets are forbidden, if not on the full-size aircraft.)
- f) From the side view of the model aircraft (with stabilizer set at 0° incidence) and on the engine axis line reference, the wings and horizontal tail position must be seen as they are on the full size subject aircraft: On the axis or above or below.

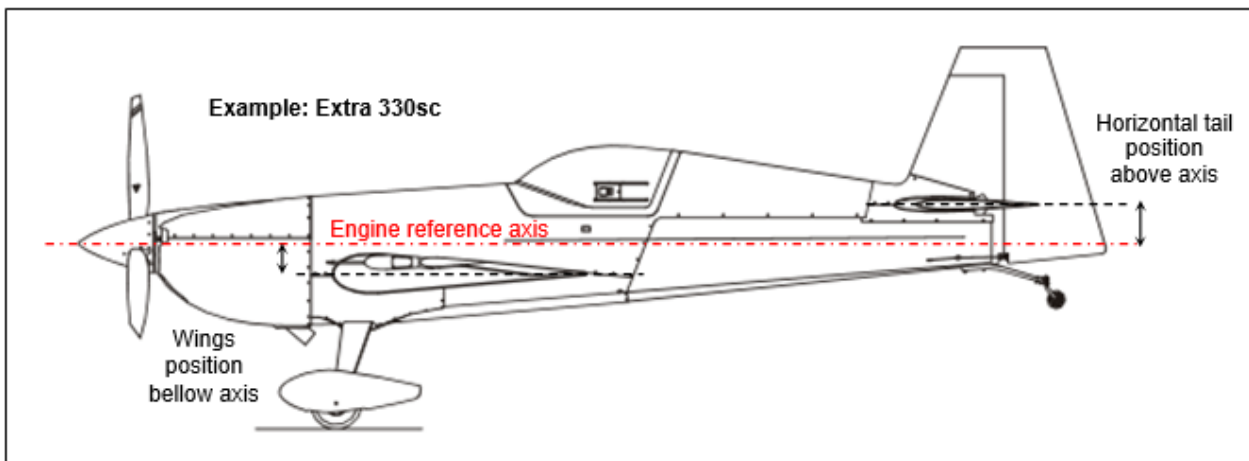

2. Sound / Noise Level test:

- a) The maximum noise level will be 94 dB(A) measured at 7 m from the centre line of the model aircraft with the model aircraft placed on the ground over concrete or macadam at the flying site. If a concrete or macadam surface is not available then the measurement may be taken over bare earth or very short grass in which case the maximum noise level will be 92 dB(A).

cont.../

- b) The tolerance of the sound/noise level measurement is the specified tolerance of the manufacturer of the measuring instrument.
- c) With the propulsion device running at 5700 rpm (+/- 10%), the measurement will be taken 90 degrees on the right-hand side, with the nose of the model aircraft pointing into the wind. The Class 1 SLM (Sound Level Meter) microphone shall be placed on a stand 30cm above the ground in line with the propulsion device other than the helper restraining the model aircraft, and the sound steward, nobody or sound/noise reflecting or sound absorbing objects shall be nearer than 7 m from the model aircraft or the microphone. The sound/noise measurement shall be made as a part of model processing. Electric powered model aircraft must have installed the same batteries for all model processing procedures. The sound test area must be located in a position that does not create a safety hazard to any person around.
- d) In the event of a model aircraft failing the sound/noise test, indication of the result or the reading shall be given to the competitor and his team manager. The model aircraft shall be impounded by a flight line official immediately following the sound test. The competitor and his equipment shall remain under supervision of the flight line official, while some modifications or adjustments may be made and the propulsion battery fully recharged. The model aircraft shall be re-tested under regular operational conditions within 90 minutes by a second noise steward using a second sound level meter, and in the event that the model aircraft fails the re-test, the model processing fails.
- e) If the technical verifications are not in accordance with the rules, the model aircraft is not allowed to fly.

5.10.4. Number of flights

A competition is formed by two independently-scored series: Classic Aerobatics series and Free-style series.

The classic aerobatics will have the two following rounds:

- A minimum of two flights of 1 known sequence, valid for one year.
- A minimum of two flights of different unknown sequences. These unknown sequences are given to each pilot before the round, without any possibility of practising the sequence. The difficulty of this round shall be equivalent to that of the known sequence.
- The best known flight, and the best unknown flight normalized scores will be considered.

The Free-style series will include two flights of a four-minute free-style program, chosen by the competitor. The best normalized score of the two flights will be considered.

5.10.5. Definition of an attempt

There is an attempt when the competitor is given permission to start.

An attempt starts when the pilot or their assistant indicates to the competition judges the entry in the box, by an audible and visual signal meaning BOX or IN THE BOX (or equivalent expression) in the official language of the competition.

If no signal is made by the pilot or the assistant, the judges will not score the flights and will inform to the Director of the contest.

When the signal is made, the judges will start the score of the full figure made by the pilot, scoring "zero" the previous ones.

5.10.6. Number of Attempts

Each competitor is entitled to one attempt for each official flight.

Note: An attempt can be repeated at the contest director's discretion only when any unforeseen reason beyond the control of the competitor, causes the model aircraft to fail to start (e.g. there is radio interference). Similarly, in a flight that is interrupted by any circumstance beyond the control of the competitor, the competitor is entitled to a reflight, with the entire sequence being flown and judged, but only the affected figure and the unscored figures that follow will be tabulated. This reflight should occur on the first flight after the judges' break or last in the round, in front of the same set of judges, or, if it involves a protest, as soon as the FAI Jury has deliberated and

communicated the outcome of the protest to the contest director. The result of the reflight will be final.

5.10.7. **Definition of an Official Flight**

There is an official flight when an attempt is made whatever the result.

5.10.8. **Definition and number of helpers**

A helper may be another competitor, or an officially registered supporter. Each competitor is permitted one helper (usually the caller) during the flight. Two helpers may be present and assist during the starting of the propulsion device. One person, either a helper or the caller, must place the model aircraft for take-off and keep the model aircraft restrained before take-off.

In exceptional circumstances, another helper may join the competitor and caller/helper during the flight, but only to hold a sun-shield as protection from direct sunlight or an umbrella as protection from the rain. These protection devices must not interfere with the judges' vision of the figures. Physically disabled competitors requiring an additional helper and/or caller or other assistance, must request permission with full details, with their entry, from the organiser of a competition. This additional assistance must be provided by the competitor, must not give him an unfair advantage over other competitors, and must not unduly delay or interfere with the running of the competition. Except for communication between the caller and the competitor, no other performance-enhancing communication with helpers is permitted during the flight.

5.10.9. **Aerobatic airspace**

a) X-Axis and Y-Axis:

The X-Axis is the main flight axis, parallel to the flight line. The Y-Axis is perpendicular to the X-Axis (flight line).

Depending on local airfield conditions, the organisers shall define an X-Axis of flight line so that the sun does not interfere with competitors or judges.

The X-axis can only be changed between rounds of flights and not during a round.

b) Safety line:

From the competitor's position, the "safety line" is located 20 metres ahead of the pilot point, 30 metres ahead of the judges and a minimum of 50 metres ahead of the spectators.

This line marks the "no-fly" zone for safety reasons and the aircraft must at all times remain on the flying side of the safety line. The safety line extends to infinity. The judges shall zero (0) any figures where the aircraft completely or partially crosses the safety line. For repeated safety line violations by a competitor during a flight, the contest director may ground the flight in progress and zero the round. If a competitor repeatedly violates the safety line, the contest director may disqualify the competitor.

If there is no natural barrier or demarcation that can be used to clearly mark the safety line, the contest director must set up clearly visible markers at the safety line distance for the judges to use in enforcing line observance.

c) Judges position:

The judges shall be seated on a line parallel to the X-Axis behind the competitor's position.

5.10.10. **Marking**

- a) Each judge has to assess each figure and any other relevant action of the competitor individually and independently from the other judges.
- b) Take-off and landing procedures are not judged and are not scored.
- c) If a model aircraft is, in the opinion of the judges, unsafe or being flown in an unsafe or inappropriate manner, they may bring this to the attention of the flight line director, who may instruct the pilot to land.
- d) Each figure is scored with a mark on a scale of 10 to 0. Half (0.5) points may be used in judging. Points are deducted for imperfections following the criteria for judging as per the *Large R/C Aerobatic Power Aircraft Official Judging Guide*.

- e) Figures must be performed where they can be seen clearly by the judges. If a judge, for some reason outside the control of the competitor, is not able to follow the model aircraft through the entire figure, the Judge will give a mark of “Average” or “A” to that figure. In this case, the judge’s mark for that particular manoeuvre will be the average of the numerical marks given by the other judges.
- f) If a judge misses seeing a figure, or any part of a figure such that a grade cannot be given with full confidence, the Judge will give a mark of “Average” or “A” to that figure.
- g) If all the judges give an “A” mark to a figure, then the pilot is allowed to refly this figure. This reflight should occur on the first flight after the judges’ break or last in the round, in front of the same set of judges. The result of the reflight will be final.
- h) Any figures not completed, or flown out of sequence with the stated schedule shall be scored zero (0). Zero scores do not need to be unanimous, except in the case where an entirely wrong figure was performed. Judges must confer after the flight in this case, bringing it to the attention of the flight line director/contest director on site.
- i) Degree of difficulty factor (K-factor) values shall be assigned to individual figures based upon the current Aresti Aerobatic Catalogue located on the Aresti website. When calculating contestant scores, each individual figure mark shall be multiplied by its K-factor. The flight raw points score shall be the result of summing the “K-factored” (figure marks multiplied by K-factor) scores

1. Airspace Control Score:

- a) Judges will evaluate each individual sequence flown, in its entirety, for overall airspace control. Each judged Known and Unknown sequence, shall have one “figure” added to the end of the score sheet, after individually judged figures. This figure shall be known as the Airspace Control Score and will be assigned by each judge. The Airspace Control Score will have a 15 K value.
- b) The airspace control will be scored with a mark on a scale of 10 to 0. Whole marks will be used for scoring. This mark will then be multiplied by the 15 K value and included in the total flight raw points score for the sequence.
- c) The following standard will be used for assessing the pilot’s performance in maintaining control and awareness of the aerobatic airspace and for placing figures in the airspace in a manner that allows the figures to be optimally judged.
- d) The highest standard for Airspace Control will be the pilot that exhibits a significant ability to control the location of the aircraft inside the airspace, relative to the judges, which results in a tight footprint and has the aircraft such that it can be optimally judged at all times. The pilot that exhibits excellent airspace control should receive a mark ten (10).
- e) The lowest standard for Airspace Control will be the pilot that exhibits a poor ability to control the location of the aircraft inside the airspace, relative to the judges, which results in an excessively large footprint and has the aircraft consistently so far away as to be difficult to properly judge. The pilot that exhibits very poor airspace control should receive a mark zero (0). Pilots exhibiting airspace control within the range of these two standards will be graded with a range of possible marks from ten (10) to zero (0) in whole point increments.

2. Sequence break penalty:

When a break in Sequence occurs, a break penalty of 100 points must be assessed against the competitor’s raw points score prior to normalizing.

3. Score publishing:

The individual figure marks given by each judge for each competitor must be made public at the end of each round of competition. The score board/monitor must be located in a prominent position at the flight line, in full view of the competitors and the public.

cont.../

5.10.11. Classification

- a) Each flight shall be normalized to a standard 1000 points. The pilot with the highest raw points score receives 1000 points for the flight. Each pilot thereafter shall have their raw points score divided by the high raw points score giving a percentage of that high raw score, which is then multiplied by 1000 to get the normalized score. Scores shall be rounded to two (2) places of decimal accuracy.
- b) For example: Contestant A wins the flight with a raw score of 4850 points. Contest B is second with 4766.5 points. Contestant A receives 1000 points for the flight. Contestant B's score is 982.78 points ($4766.5 \div 4850 = 0.982783 * 1000$ for 982.783, which rounded to two (2) places of decimal accuracy for a final score of 982.78).
- c) Final classification of the Classic Aerobatics will be done considering the sum of the scores of the two best normalized flights: known and unknown, multiplied by the following coefficients:

Known 50%

Unknown 50%

The highest combined scores will determine the winner. In case of ties, all the normalized flights of the contestant shall be used to determine the winner.

Note: For open international events, national championships, and domestic competitions where more than one flight of each round have been completed, the sum of the scores corresponding to the best known flight and the best unknown flight may be used to determine the individual winner in the Classic Aerobatics category. The same system will be used to decide the winners of the Free-style category.

5.10.12. Judging

- a) For open international events with 30 or fewer competitors, the organiser must appoint a minimum of 1 panel of 5 judges. The judges in the panel/s must be selected according to CIAM General Rules C.9.d.
- b) For domestic competition, the organiser may appoint 1 panel of minimum 3 judges.
- c) The highest and lowest marks for each figure must be discarded, but only when the panel is of four or more judges.
- d) For open international events with more than 30 competitors, the organiser must appoint 2 panels of 5 judges (a total of ten judges). The judges in the panels must be selected according to CIAM General Rules C.9.d.
- e) Panels of judges shall judge all competitors an equal number of times and all competitors shall have an equal opportunity to fly before all judges. Substitution of judges, which precludes equal exposure by all contestants, shall be avoided. If adverse weather conditions preclude equal exposure for all competitors, the results of the round may be disregarded at the discretion of the Contest Director.
- f) The invited judges for an open international event, must have had a reasonable amount of F3M judging experience of known current sequence.

5.10.13. Organisation for R/C Large Aerobatic Model Aircraft Contests

- a) Competitors may make use of the model aircraft processed by another competitor. However, if that competitor did not process the model aircraft, then it must be re-registered and re-marked appropriately.
- b) For transmitter and FM frequency control see CIAM General Rules C.16.2.
- c) The flight competitors' order of each group for the first Known flight 1 of preliminary rounds will be established by a random draw. The flight competitors order for flights two (Unknown 1), three (Free-style1), four (Known 2), five (Unknown 2) and six (Free-style 2) will start 1/6, 1/3, 1/2, 2/3 and 5/6 down the list order with decimals rounded-up.
- d) The flight competitors order for the first Known flight 1 of final rounds will be established by a random draw. The flight competitors order for flights two (Unknown 1), three (Free-style1), four (Known 2), five (Unknown 2) and six (Freestyle 2) will start 1/6, 1/3, 1/2, 2/3 and 5/6 down the list order with decimals rounded-up.

- e) The draw for flight order will be done for each flight line, so that FM frequencies are separated with two competitors in between.
- f) Competitor identification numbers will only be assigned after this flight order draw, by competitor group, and in numerical ascending order.
- g) During his flight the competitors must stay in the proximity of the judges and under the supervision of the Flight Line Director.
- h) Competitors must be called by a flight line official at least five minutes before they are required to occupy the starting area.
- i) If the FM frequency is clear the competitor will be allowed to collect the FM transmitter from the transmitter pound. The competitor and his helper(s) then occupy the starting area so that a radio check can be performed to verify the correct functioning of the radio control equipment. If there is a FM frequency conflict, the competitor must be allowed to do a radio check of a maximum of one minute before the beginning of the starting time.
- j) The time keeper will audibly notify the competitor when the minute is finished and immediately begin timing the starting time.
- k) For electric powered models, the electric power circuit(s) must not be physically connected, before the starting time is began and must be physically disconnected immediately after landing.
- l) A competitor is allowed to a two (2) minutes of propulsion device starting time. The timing starts when the contest director, or timekeeper, gives an instruction to the competitor to start.
- m) The competitor may not start his propulsion device model aircraft unless he has been instructed by a flight line official to do so. Deliberate starts at the flight line during official flying to check the propulsion device will be subject to disqualification from that round.
- n) One person, either a helper, or the caller, must place the model aircraft for take-off and hold the model aircraft before taking off. If the model aircraft taxis to take off point without being held by an assistant, the contest director/time keeper will advise the competitor and helper that the flight may not proceed. The flight shall score zero point.
- o) If after two (2) minutes the contestant is unable to start the propulsion device, he will move to the first flight after the judges' break or at the end of the round rotation. If the contestant fails to start a second time, he shall receive zero for the round.
- p) The contestant has one (1) minute from the time the wheels leave the ground during takeoff to start the sequence.
- q) The model aircraft must take-off and land unassisted, that is, no hand launched flights.
- r) There shall be no time limit for sequence execution.
- s) During the flight, the pilot and his helper/caller (if required) must stay in the designated position in front of the judges, at the pilot point and under the supervision of the flight line director. The pilot must wear or display his identification/start number.
- t) Before to start the sequence and before landing, competitors shall only be allowed to perform the following trim and positioning manoeuvres:
 - Turns.
 - Half Cubans with only a single $\frac{1}{2}$ roll on the 45 down line.
 - Reverse Half Cubans with only a single $\frac{1}{2}$ roll on the 45 up line.
 - The $\frac{1}{2}$ roll is optional based on aircraft positioning required starting the sequence.
 - Half loops up or down (Immelman or Split S) with only one half roll on entry or exit.
 - Single half roll to inverted immediately before to start the sequence for the case in which an inverted entry to the first figure is required.
 - Single half roll to upright after the end of sequence for the case in which an inverted exit from the last figure is required.
 - A vertical up or down line with a simple push/pull for entry and exit. A single $\frac{1}{2}$ roll is allowed on this vertical line only if required to orient the aircraft properly for entry to the first figure.

- Humpty Bump with $\frac{1}{4}$ of upward roll and $\frac{1}{4}$ of falling roll.

Exceptions to this limitation may only be directed by the contest director or flight line director in the normal course of safely managing the airspace. Pilots will follow such directions and no penalty will apply.

- u) Turnaround manoeuvres may not be performed at low altitude or directly in front of the judges. No other aerobatic manoeuvres are allowed immediately following the airplane breaking ground except for the Four Minute Freestyle. Any infraction shall result score zero point for the flight.
- v) No public address or commentary should be made during flights.
- w) The contestant has two (2) minutes between the end of the sequence and touchdown for landing, unless required to hold upon command from the appropriate official.
- x) The scoring will cease at the end of sequence except for the sound presentation score, which is judged after the model aircraft has landed, irrespective of the time.
- y) The flight ends when the model aircraft has landed.
- z) The propulsion device must be shut-off immediately after the model aircraft has landed, otherwise the flight shall score zero points.

Execution of figures:

The figures must be executed during an uninterrupted flight in the order in which they are listed in the sequence. The competitor may make only one attempt at each scored figure during the flight.

The direction of the first manoeuvre or the landing may be different from that of the take-off.

5.10.14. Sequences of figures

- a) The known and unknown sequences must be drawn according to the current FAI ARESTI Aerobatic catalogue.
- b) The known sequences (Unlimited and Unlimited Alternate) are valid for a one year period.

They are sourced from the International Miniature Aerobatic Club (IMAC) and will be published on the CIAM website as soon as possible. They will be effective 1st January of the year.

Unlimited Alternate sequence is used when the local airfield has restricted aerobatic airspace on Y axis.

The organiser must inform the competitors before the competition which known sequence will be flown.

- c) The unknown sequence must be completely new, unknown, and equal in difficulty factor to the known sequence.
- d) The Unknown sequence is given to the competitors in the evening before the competition day, or on the morning of the competition day with a minimum of two (2) hours before the round, with no possibility of practice flying. In a proven case of a competitor having practised the unknown sequence with a flying model or on a computerized flight simulator, the competitor must be disqualified. Hand-held stick models are permitted.
- e) Before the beginning of the round of the unknown flight, the judging co-ordinator will brief the judges and the competitors to clearly explain the figures (if needed the figures can be corrected), and what is expected from the competitors.
- f) Knowledge of the Aresti cryptographic system is mandatory to all competitors and judges. No text descriptions will be given.
- g) For each figure, judges and competitors must refer to the Large R/C aerobatic Power aircraft official flying and Judging Guide rules that define all manoeuvres, and the referring errors that can be avoided.

5.10.15. Freestyle program

- a) The (4) four minutes Freestyle program give a competitor the opportunity to demonstrate his own skill and the qualities of his model aircraft. There are no rules governing the composition of the program. However, safety is of prime importance.

- b) The freestyle program is freely composed by the competitor and flown in harmony to simultaneously played music of his choice. Any possible flight manoeuvres may be flown and "show effects with enhancers" presented. It is permitted to perform different programs in conjunction with different music in each round.
- c) The model aircraft flown by a competitor in the freestyle round may be different than for the known and unknown rounds. This model aircraft must conform to the general characteristics of the F3M class.
- d) The maximum duration of a freestyle flight is four (4) minutes.
- e) The timing and music begins when the pilot or caller makes a visual signal indicating to the judges when the pilot is starting the program (during take-off or maximum 1 minute after take-off)
- f) After the end of the four-minute period, the judges cease to consider any further manoeuvres that may have been performed. If the model aircraft is still airborne it must be landed immediately, otherwise the judges will mark a zero score for the criteria "Technicality of the manoeuvres" (K20).
- g) If the pilot lands any time prior to 3 minutes 30 seconds (three and one-half minutes) the judges score is "prorated" Example: the pilot lands at the three (3) minutes time. The judges will score the contestant as through he flew four minutes. The score room will tabulate the scores normally and the pilot will receive three-fourths (75%) of the judges score for his final score. If the pilot lands any time after three and one-half minutes there is no penalty.
- h) Specific circumstances that will disqualify the competitor's flight:
 - A: If the model airplane touches the ground during the flight or crashes, it is a disqualification.
 - B: If the model airplane goes behind the deadline, it is a disqualification.
 - C: If the pilot performs dangerous or unsafe manoeuvres or high energy manoeuvres directed at the judges or spectators, it is a disqualification. (As determined by a majority of the judges and/or the line officer/steward).

5.10.15.1. Marking Criteria

Judging of the Freestyle program comprises three elements. Each element contains several criteria, with marks ranging from 10 to 0. Half (0.5) points may be used in judging. Each mark is multiplied by a difficulty coefficient (K-Factor).

Difficulty - Technicality of the manoeuvres: K= 20.

Complicated and technically challenging manoeuvres must be awarded higher marks, provided there is not a lack of quality in their execution. Simple and less complex manoeuvres should attract fewer marks.

Diversity: K= 20

The competitor must avoid repetitive use of the same manoeuvres, and only in exceptional circumstances will repeat manoeuvres be tolerated to emphasise a particular passage in the music.

Harmony with music, program choreography: K= 30

The music (choreography) has to enhance the presentation and to create a complementary atmosphere. The flight performance should be synchronised with the music and must not be a "3Dsketch" with background music. On the other hand the music must not detract from the presentation. The selected music piece(s) should contain fast-slow, soft-loud and dramatic sections. The manoeuvres should follow the music and end with it. The mood of the selected music should be reflected in the manoeuvres and the presentation. Show effects can support this. Music pieces with little contrast, variety or tempi result in downgrades.

Precisión - Quality: K= 30.

The entire flight must be devoid of "missed" manoeuvres, and must exhibit all-round good quality. The fact that it is a freestyle schedule must not allow the performance to become sub-standard in technicality and quality. It is not intended to be a circus performance.

Enhancers: Smoke producing devices, or streamers: K=10

To judge the effects of the show, the following rules will be used:

The maximum score is 10.

Engine smoke: 0 (without smoke) – 2 (light smoke) – 4 (dense smoke).

Streamers: 0 (no streamers) – 1 (capacity to launch streamers) – 2 (properly used and fully deployed streamers).

Smoke cartridge: 0 (without cartridges) - 1 (one cartridge on the fuselage) – 2 (two cartridges on the wings).

Confetti: 0 (without confetti) – 2 (throwable confetti, only biodegradable)

5.10.15.2. Safety

- a) The contest director will nominate a safety line officer/steward. This officer/steward is in charge of safety and will be located within hearing distance from the competitor. The safety steward must observe the model aircraft and the competitor's actions during a flight, and is empowered to instruct a competitor to terminate his flight and to land his model aircraft immediately if necessary during a safety conflict.
- b) From the competitor's position, the "safety line" is located at 20 metres ahead of the pilot point. This line delimits the "no-fly" zone for safety reasons and the aircraft must at all time (except for take-off and landing) remain on the side of the safety line, away from the contestant, pits and spectators. The safety line extends to infinity.
- c) If there is no natural barrier or demarcation at or beyond 20 m that can be used to clearly mark the safety line, the contest director must set up clearly visible markers at the safety line distance for the safety line officer/steward to use in enforcing deadline observance.
- d) In the following special cases, the pilots will score zero in the free-style sequence.
 - When the safety line is crossed (excluding the take off and the landing).
 - To lose fragments of the plane (except fragments of the effects).
 - Touching the land, including a tree or the grass.

ANNEX 5C

F3M R/C LARGE AEROBATIC AIRCRAFT OFFICIAL FLYING AND JUDGING GUIDE

5C.1. Purpose:

The purpose of this R/C Large Aerobatic Aircraft Flying and Judging Guide is to provide an accurate description of each type of figure used in competition and to provide a reference for use in developing a uniformly high standard of judging in all CIAM sanctioned contests. Study of this guide by the competitor will help him or her learn exactly what is expected, while study by the judges will help them decide precisely how well the competitor meets these expectations.

Flying and judging are very similar in nature. This is why contestant judging is generally promoted. Nevertheless, there are some key differences between judges and pilots, mostly related to Mental Attitude and Technical Knowledge. Reference to any gender in this document shall include both male and female.

5C.2. Mental attitude: Mental attitude by itself can be divided into four (4) sub-categories:

5C.21. Bias: Bias can either be conscious or unconscious. The conscious bias is fortunately rare, and would be for instance when a judge deliberately awards a score lower or higher than the competitor deserves. The word for that action is cheating and it shall not be tolerated. Conscious bias can also occur because a friendship or regional relationship with the competitor. Most problems with bias are of the unconscious or unintentional type since they are more prevalent. A good example would be the 'halo' or recognition for a champion or well-known flyer who might unintentionally be awarded extra points based on recognition alone. This can work against an unknown flyer having a great day. This type of bias can also work against the champion flyer, just because the judge unconsciously might want to see a new face in the winner's circle. Another example might be bias towards a certain type of airplane like mono versus biplane, or bias towards a style of flying.

For instance, a pilot cuts crisp corners on square manoeuvre versus a flyer with a more graceful style. Sometimes we even see an equipment bias where a judge may unknowingly try to support a previous personal opinion regarding a certain brand of radio, certain type of engine, or size of aircraft. These unconscious biases are easily understood as we all have personal preferences. Nevertheless, the judge must try hard to base his or her score solely on the quality of the flight, and nothing more.

5C.22. Self-confidence: The self-confidence factor is based on knowledge instead of arrogance or ego. A judge with self-confidence can score a pilot fairly, whether he is a World Champion or not. A judge with self-confidence will not be uncomfortable in giving a wide range of scores in a single sequence. Scores as low as 2 or 4, or as high as 9 or 10 will not be uncommon.

5C.23. Sense of independence: A judge doesn't operate in a glass cage but shares the flight line with another judge and scribes. The judge cannot allow himself or herself to be influenced by more dominant or experienced personalities sitting nearby. Judging is an independent exercise and caution should be exercised not to influence or be influenced by others on the flight line. If scribes are used, scores should be communicated using a low tone voice so that the other judge and the pilot cannot hear and be influenced by it.

5C.23. Adherence to the rules: Adherence to the rules is probably the most significant of all the elements required to make a good judge. A good judge has developed a sense of fair playing and knows that a good contest is one in which everyone plays by the same rules. Anyone sitting in a judging chair must adhere to the rules existing at that time or disqualify him or herself.

5C.3. Technical knowledge:

Technical knowledge employs the use of an organised system of downgrading as well as the need to be consistent and accurate. The downgrading or deficit grading system assumes that the contestant is going to fly a perfect figure that starts with a 10, and then downgrades it based on the mistakes observed as they occur, rather than falling into the trap of scoring on overall impression. It should be assumed by a judge that a contestant is going to fly a well-formed figure, so he should start with the grade of 10. As he watches the figure, he then begins to find fault with what he sees and starts downgrading as it progresses. This system is preferable to waiting until the figure is finished, and tries to assign a grade on overall impression. The latter can be erratic and inconsistent, and also confines grading into a too narrow range. However, as a final check, the score should be consistent with the figure's overall quality.

Every judge should strive for a high degree of consistency and accuracy. The most important aspect of consistent judging is for each judge to establish his or her standard and then maintain that standard throughout the contest.

5C.4. FAI ARESTI System (condensed)

The F3M Large R/C aerobatic power aircraft aerobatics sequences are based on a catalogue of figures adopted by the FAI (Fédération Aéronautique Internationale), from the “ARESTI Aerobatic Catalogue (Condensed)” for full scale aerobatics. The catalogue consists of the following nine (9) families of figures:

- Family 1 – Lines and Angles
- Family 2 – Turns and Rolling Turns
- Family 3 – Combinations of Lines
- Family 4 – (Not in Use)
- Family 5 – Stall Turns (Hammerheads)
- Family 6 – Tail Slides
- Family 7 – Loops and Eights
- Family 8 – Combinations of lines, Angles, and Loops
- Family 9 – Rolls and Spins

It is beyond the scope of this Flying and Judging Guide to explain in detail the structure of the ARESTI catalogue, and how to read the ARESTI drawing language used. A good judge (as well as a pilot) must become very familiar with the above and should be able to quickly understand the figure simply by looking at the ARESTI drawing. The complete catalogue of figures is available directly from the ARESTI Web site at (<http://www.arestisystem.com>). Judges and pilots are strongly encouraged to download this document for personal reference.

5C.41. Rules: R/C large aerobatic aircraft class F3M has several rules that differ from either Full Scale Aerobatics (CIVA) or class F3A. Because the judging pool used in F3M contests sometimes comes from both or either of those two groups, it is useful to go through the major differences:

Rules	CIVA Powered Aircraft	F3M / AMA RC SCALE AEROBATICS	F3A
Downgrade one (1) point for each deviation of:	5 degrees	10 degrees (1/2 point for 5°)	15 degrees (1 point for 15°)
Judging criteria:	Aircraft attitude and Flight path	Flight path	Flight path

5C.42. Definitions:

There are some words and phrases which are used consistently throughout the text in a very precise sense, and it is as well to define at the start the sense in which each is used:

Figure: Each individual component of a sequence, which may comprise one or more manoeuvres in combination; it starts and ends with a horizontal line.

Manoeuvre: Any one of the basic aerobatic movements, which may be combined to make a figure (e.g. an avalanche is one figure consisting of two manoeuvres -- loop and flick roll)

Mark/Point/Score: Marks are assigned (from 0 to 10) by judges, and may be devalued by various point values. The score is calculated by multiplying the judges' marks by the coefficients (K factors) and adding the products.

5C.5. Flight Path, Aircraft Attitude, and Wind Correction:

R/C large aerobatic aircraft class F3M requires all figures within the sequence to be wind corrected.

Judges should evaluate any figure focusing primarily on the aircraft flight path, but at the same time, also downgrade for any variation of the aircraft attitude that is not directly related to maintaining a correct flight path.

5C.51. Flight path. Think of the aircraft condensed into a single dot and watch the path this dot takes through the sky. This is the flight path, or track, or the aircraft's centre of gravity. Judging the flight path consists of comparing the observed path with fixed references such as the horizon, or the X and Y-axis of the aerobatic airspace.

5C.52. Attitude. The aircraft attitude is defined as the position of the aircraft in the sky, and is characterised by the variations it has on the yaw, pitch, and roll axis. In a “no-wind” and normal speed condition, the aircraft’s attitude (its heading) will generally point in the same direction as the flight path. In case of a cross wind, the aircraft attitude must vary (on the yaw axis) in order to maintain a constant and straight flight path, as required by the Large R/C aerobatic power model aircraft rules (Fig. 2).

Also, a reduction in speed will force the aircraft to change its pitch in order to maintain the correct flight path (Fig. 3).

Depending the type of aircraft (low wing, high wing, etc.), the flight attitude might be different from one to another to maintain the correct flight path. Judges should disregard this difference in attitude and only concentrate on the flight path described by the aircraft.

5C.53. Wind correction. When judging a manoeuvre, understanding what constitutes wind correction, and what is not, is one of the toughest challenges. The general rule is that judges should ignore any aircraft change of attitude required to maintain a correct flight path. At the same time, the usual 0.5 point deduction per 5 degrees of deviation shall be applied to anything that is not related with wind correcting. For instance, when the wind is blowing parallel to the flight path, the pilot flying a vertical line might use its elevator to change the aircraft’s attitude in order to maintain a straight vertical flight path (Fig. 4).

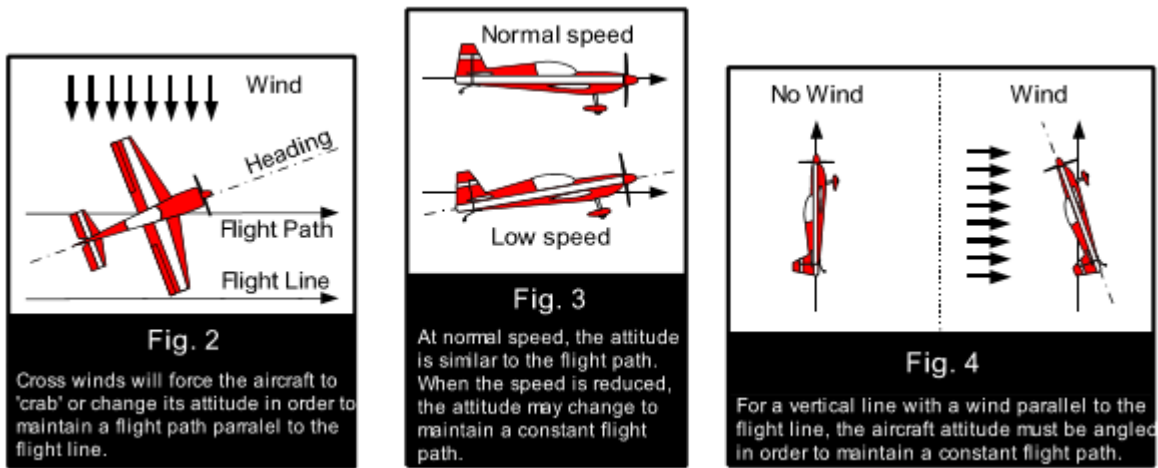

This change of attitude should not be downgraded. On the other hand, any bank angle of the wing in the roll axis should be downgraded using the standard rule of 0.5 point deduction per 5 degrees (Fig. 5). The judges should only downgrade for induced pilot corrections and disregard any sudden attitude changes due to wind bumps. Always give the competitor the benefit of the doubt when not sure.

The only manoeuvres that are not to be wind corrected are the ones involving a stalled condition, such as a Stall Turn (otherwise known as “Hammerhead”), Tail Slide, spin and snap roll(s) (otherwise known as a “flick roll”). During the period of time that the aircraft is in a stalled, or near stalled condition, any wind drift should be disregarded by the judges and not downgraded.

Wind correction should be used throughout the aerobatic airspace. Any drift observed on any line (horizontal, 45 degrees or vertical) should be downgraded using the 0.5 point deduction per 5 degrees rule (Fig. 6).

For instance, in the case of a Stall Turn performed with a severe crosswind, the vertical line will start directly after the ¼ loop. This is the first point of reference to be used for the upline. The flight path on the way up is 15 degrees off compared to the perfect vertical up line; the downgrade should then be 1.5 points. When the aircraft starts its Stall Turn, it is in a stalled condition and no downgrade should be applied for wind drift during that time. Once the rotation is complete, a new reference point should be established for the perfect vertical downline.

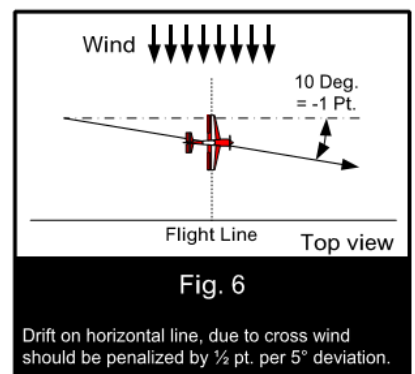
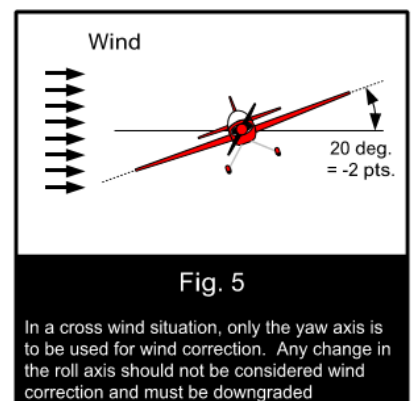

If the flight path on the downline is 20 degrees off, the downgrade should then be 2 points (Fig. 7).

The competitor is required to make the shape of all manoeuvres perfect regardless of the wind conditions. Loops and partial loops must be round, vertical lines must be perpendicular to the horizon and horizontal line parallel to the X or Y-axis. For 45-degree lines, judges must make an allowance for the aircraft's position relative to their own.

A true 45 degree line flown at the end of the aerobatic airspace will appear steeper when flown towards the end of the airspace and shallower when flown towards the centre. Judging is of the true line flown and judges should not downgrade the manoeuvre for visual deformation due to the angle it is observed. Always give the competitor the benefit of the doubt when not sure.

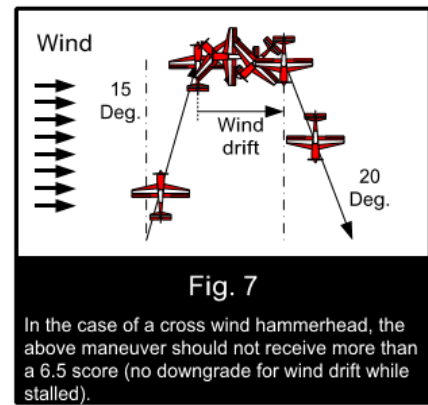

5C.54. Grading of Figures: The judges will independently assess the quality of each figure and its components as performed in the sequences, grading with numbers from ten (10) to zero (0) in increments of one-half (0.5) point. A grade of ten (10) represents a perfect figure in which the judge saw no deviations from prescribed criteria.

Remember, it is the judge's job to find fault: be a nitpicker. On the other hand, give a grade of 10 if you see a perfect figure—but if you are really being critical, you won't see too many. Don't get in a rut. Guard against confining your grades in too narrow a range. If you watch carefully and grade consistently, you will find yourself giving an occasional 2, 3, or 4 on some sloppy figures that are not quite bad enough for a zero. You will also be giving an occasional 9 or 10 for the superlative figure which you can find little or no fault.

As a judge, you are expected to grade only against one standard, and that is perfection. The performance of the aircraft, the difficulty in performing a figure (on the basis of your personal experience or perception), the weather condition or the pilot's name and reputation should not be considered in formulating your grade.

5C.6. Grading Principles

5C.6.1. General principles.

When grading the quality of the performance of individual figures, judges should consider the following general principles:

- a: The geometry of the figures (including the shape, radii, angles, flight path, direction of flight, heading and bank angle) must comply with the prescribed criteria.
- b: The precision of the performance compared to the criteria as explained later in this guide.
- c: The smoothness of the performance
- d: The distinctly recognisable start and finish of each figure with a horizontal line.
- e: The figure must be the one depicted on the flimsy (Form B or C) appropriate to the direction of the flight chosen by the pilot to perform and flown in its proper order within the sequence. For figures with a Y-axis component, it is the pilot's discretion, in addition to fly inbound or out bound, as to which direction to fly the turn, left or right. For Family 9, Rotational Elements it is the pilot's discretion to which direction to perform the roll or first roll, if it is unlinked roll combination. In all cases, the figure flown must have the entry and exit direction as depicted on the flimsy appropriate to the direction of flight chosen by the pilot to perform (Form B or C) in the X-axis.
- f: The grading criteria of each component will apply in a combination figure so that one overall grade for the figure will result.
- g: The length of the lines and the size of the radii caused by the flying characteristics of an aircraft are not to be taken into account in the grading.
- h: Negative figures are graded by the same criteria as positive figures.

i: Speed of aircraft is not a criterion. A reduction of grade will be applied for each deviation from the prescribed criteria for the figure. The grade will be reduced by 0.5 points for each 5 degrees of deviation.

5C.6.2: Beginning and ending of a figure. The first figure of a sequence begins at the moment the aircraft departs from its wings-level, horizontal flight path.

A figure is complete at the moment the aircraft returns to a wings-level, horizontal flight path of one fuselage plane length. The only exception to this are the exit lines in the “ARESTI Aerobatic Catalogue (Condensed)”, Families 7.4.3 and 7.4.4 (Square Loops) and 7.4.6 (Octagon Loops). Once a horizontal flight path of one fuselage plane length is established at the end of a figure, the beginning of the next figure is deemed to have occurred (Fig. 8). If an aircraft does not return to wings-level, horizontal flight before commencing the next figure, the one (1) point per figure deduction will be applied. Ref. Rule 5C.7. If the competitor corrects any errors in exit flight path, bank angle, or heading before initiating the subsequent figure, only the first figure shall be downgraded. Failure to correct such errors shall result in a downgrade to both figures.

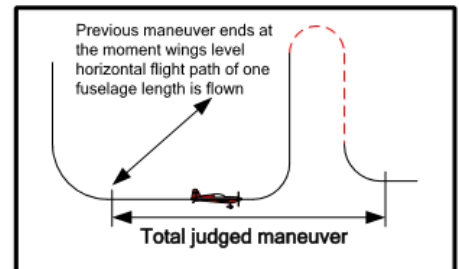

Fig. 8

The horizontal line prior the maneuver to be judged is also part of this maneuver, and therefore subject to the same downgrades as any other lines.

5C.6.3: Zero. A zero will be given for:

a: Omitting a figure in the program. In this case, only the omitted figure will be zeroed. For instance, if the pilot omits the centre figure and flies straight to do the next figure, only the centre figure will receive a zero and the next figure will be scored normally.

b: Flying a figure that deviates from the ARESTI drawing held by the judges for scoring purposes. For instance, if the pilot flies a Humpty Bump instead of a Stall Turn, the figure will be marked zero (0).

c: Adding a figure to a program will zero the next following correct figure except when it is necessary to perform a Corrective Manoeuvre (c.1) due to the previous figure not being completed as per the program. A zero will be given to the figure immediately following any other added figure, even if the following figure is performed correctly.

c.1: A Corrective Manoeuvre can only be a turn of 270 degrees or less, and /or a roll of 180 degrees or less. In this case, a break penalty will be assessed against the competitor's raw score prior to normalizing.

For instance:

1: If the exit of a figure is done upright instead of inverted (the pilot forgot to perform a ½ roll on the downline), and corrects this by doing ½ roll after the exit, on the horizontal line, the original figure will be marked zero (0) because the ½ roll was omitted on the downline, however the following figure will be scored because this ½ roll was added only to correct the attitude of the aircraft for the beginning of that next figure. (Fig. 9). A break penalty will be applied, see **Rule 5C.6.3.c.1**.

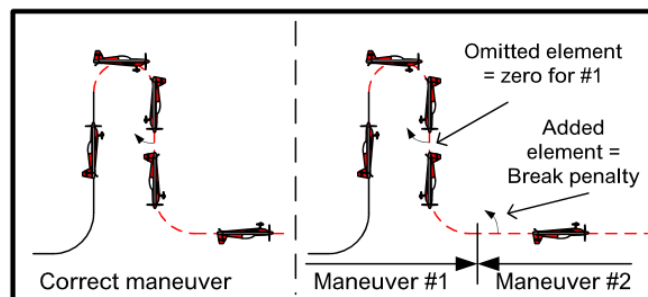

Fig. 9

If part of the maneuver is either omitted or added, all of maneuver #1 must be zeroed. The half roll performed after the end of maneuver #1 will cause a break penalty. Maneuver #2 will be judged.

2: If the pilot exits the figure in the wrong direction on the X-axis (pull instead of push at the bottom of a figure), then adds a 180 degree turn and a 180 degree roll to correct the mistake and comes back to the correct flight direction he/she will be assessed a break penalty, see **Rule 5C.6.3.c.1**.

The original figure will be marked zero (0) because the exit ¼ loop was not performed per the ARESTI, and the following figure will be scored from wings level after the completion of the 180-degree turn.

Note: Corrective actions that exceed 270 degrees of turn or 180 degrees of roll constitute a Break in Sequence.

d: Break in the sequence. A break in the sequence is characterised by a total departure from the sequence to be flown. For instance, a pilot that becomes disoriented; aborts the figure and circles around a couple of times before resuming the sequence again. Another example might be a pilot that aborts a figure thinking that the aircraft has equipment problems, makes a couple of fly-bys in order to confirm that everything is operating normal, and then decides to resume the sequence. A deadstick, or a landing during the sequence shall not be considered as a break and all remaining figures that were not flown will be marked zero (0).

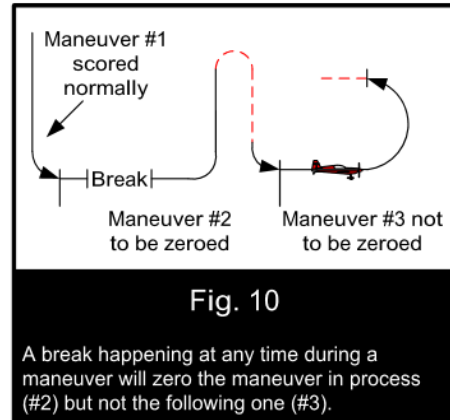

When a Break in Sequence occurs, the figure in progress (at the time of the break) should be marked zero (0) and a break penalty will be assessed against the competitor's raw score prior to normalizing. Situations may occur where a pilot performs an incorrect manoeuvre, resulting in a zero, exits that figure improperly, and then performs a break in sequence. In this instance, the pilot receives a zero for the first failed figure, and a zero for the next figure in which the Break in Sequence occurred.

Resumption of scored flight: The pilot or the caller should visually indicate to the judges his intention to resume the sequence. He should then first establish a wing-level horizontal line, call the restart of the sequence to get the judges' attention, perform the last flown figure that is to be marked zero (0), and continue the sequence from there on. Normal judging will resume after the completion of the marked zero (0) figure.

A break in the sequence related to safety, weather, for collision avoidance, or by request from the judges or the Contest Director will not be penalised.

e: Flying a figure in the wrong direction on the X-axis. The Y-axis is non-directional.

f: Any cumulative deviation in excess of 90 degrees in the roll, pitch or yaw axes that are not related to wind corrections.

g: Any figure or figures started and flown completely or partially on the pilot side of the deadline. The aircraft must clearly penetrate the deadline to receive a zero.

Judges should score each figure independently and not communicate with each other while judging of the sequence. Once the sequence is complete, the judges may, but are not required to, confer and review any figure receiving a zero, but need not agree on the score.

If a judge, for some reason outside the control of the competitor, is not able to follow the model aircraft through the entire figure, the judge will give a mark of "Average" or "AV" to that figure. In this case, the judge's mark for that particular figure will be the average of the numerical marks given by the other judges. If all the judges give a "AV" mark to a figure, then the pilot is allowed to re flight this figure. This reflight should occur on the first flight after the judges' break or last in the round, in front of the same set of judges. The result of the reflight will be final.

5C.7. Basic Components of Aerobatics:

5C.7.1: Lines

All lines are judged in relation to the true horizon and the axes of the Aerobic Airspace. Horizontal and Vertical lines are judged primarily on flight path (Ref Rule 5C.5.3 for wind correction criteria).

All figures begin and end on definite horizontal lines, and both must be present in order to earn a good grade. A competitor who rushes from one figure to another, without showing this horizontal and well-recognisable line will be downgraded by one (1) point for each missing line in each figure affected.

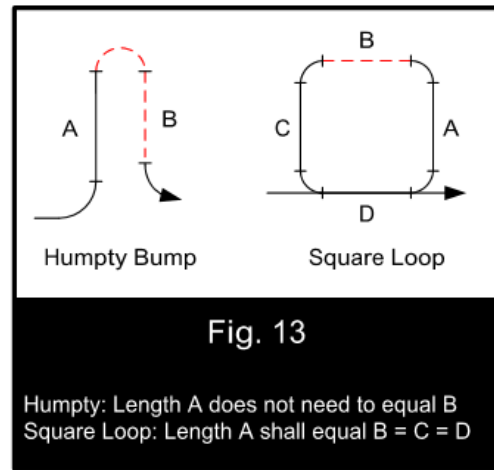
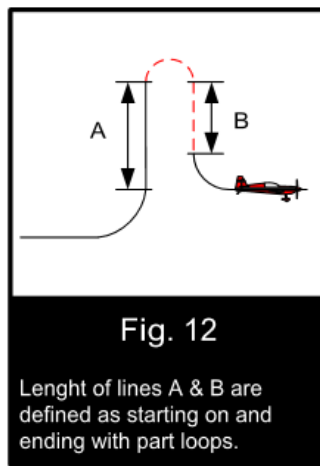
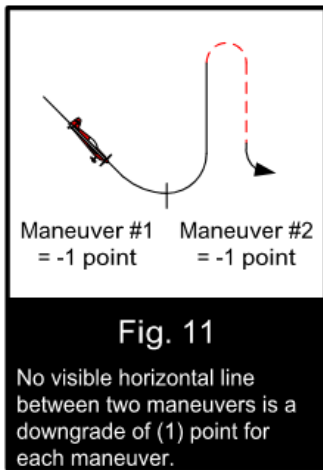

Therefore, leaving out the line between two figures will downgrade the preceding figure by one (1) point and the following figure also by one (1) point. (Fig. 11).

All lines that occur inside a figure have a beginning and an end that define their length. They are preceded and followed by part-loops.

With the exception of Family 3 figures (Three, Four & Eight Corners) and some figures in Family 7 (Loops and Eights), the criterion for the length of lines within a figure states that they do not have to be of equal length (Fig. 12). For example, the length of the lines in a Single Humpty-bump does not need to be equal, but all four lines in a Square Loop must be of equal length (Fig. 13).

Whenever any kind of roll is placed on an interior line, the lengths of the two parts of the line before and after the roll must be equal. Exceptions are when any type of roll follows a spin element. Judges should take care to judge the symmetry of the length of lines in a figure using only the length of the lines and not be elapsed time taken to fly each segment. This difference in length versus elapsed time is most noticeable in figures where rolls are placed on up-lines. As the aircraft loses airspeed, the time it takes to fly a line after the roll will be greater than the time required to fly the line of the same length before the roll.

If within a figure two or more lines must be of the same length, an observed variation is penalised by reducing the grade in the following manner (Fig. 14):

- i- A visible variation = 1 point deduction
- ii- If the lengths vary by 1:2 = 2 point deduction
- iii- And so forth up to a 3 point deduction
- iv- No line before or after roll, 4 point deduction.
- v- No line at all before and after roll = 2 point deduction.

The basis for judging line length is the first line flown. The absence of one of these lines either before OR after a roll has to be penalised by one (1) additional point. IF there are no lines before AND after the roll, the total penalty is two (2) points only.

Example: The competitor is to fly a vertical up-line with a full roll on the line. However, the aircraft is returned to level flight immediately after the roll. The deduction is 4 points: 3 points are deducted because the lines are of vastly different length and another 1 point is deducted because of the absence of one of the lines.

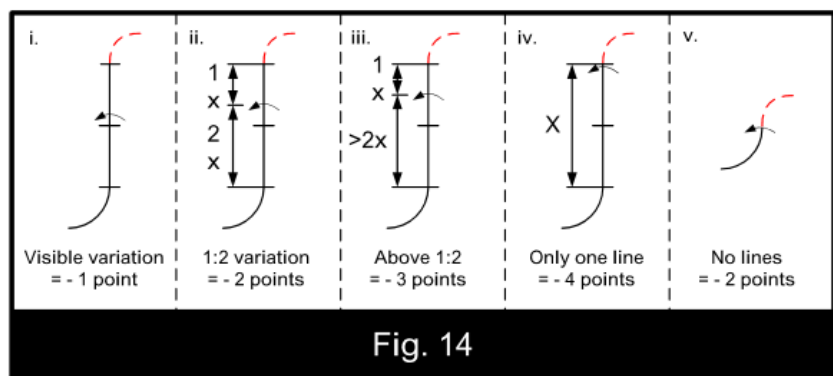

5C.7.2: Loops and part-loops

The loop is a figure from Family 7, but part-loops are integral to every other family so it is necessary to discuss the loop before going on to the other families.

5C.7.2.1: General criteria

A loop must have, by definition, a constant radius. It starts and ends in a well-defined line that, for a complete loop, will be horizontal. For a part-loop however, such lines may be in any other plane of flight. As the speed changes during execution of a loop or part-loop, the angular velocity around the aircraft's lateral axis also has to change in order to keep the radius constant. When the speed decreases, for example, to half its initial rate, the angular velocity, to keep the same radius, will be reduced by half—this is a fact of physics. Thus, the angular velocity can be an aid for the judge to gauge the radius— especially when the angular velocity in the higher part-loop is seen to be faster, as this is a clear indication that the radius is smaller. This aid becomes more important when a line separates two part-loops. Refer to section 5C.8.7 for specific criteria for judging loops and part loops.

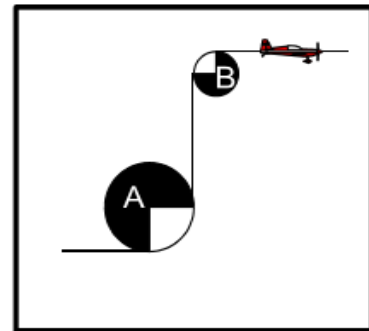
**Fig. 15**

A & B radii do not need to match

5C.7.2.2: Matching Radii. Certain figures require that the part-loop portion of the figure have the same radius. When identical radii are required depends on the figure in question. This is defined by how a particular figure is depicted (drawn) in the ARESTI Aerobatic Catalogue.

5C.7.2.2a Round Corners For any figure having more than one internal part-loop depicted in the catalogue as an actual round, or looping line, element, all such part-loops must have the same radius – with an exception for all of Family 8.8 (Double Humpty Bumps). For those figures, the radius of the second half-loop is not required to match the radius of the first one.

7.2.2b Corner Angles For any figure having more than one internal part-loop depicted in the catalogue with a hard, or corner, angle, no such part-loop is required to match the radius of any other part-loop depicted in the same figure – with the exception of figures which must maintain a set geometric proportion, i.e.,

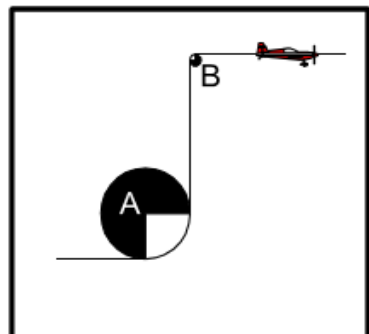
**Fig. 16**

Sharp angles, or 'corners' must be downgraded.

- All of Family 3 (Combination of Lines)
- Family 7.4.3.x to 7.4.6.x (Hesitation Loops)

For example, the quarter-loop at the top of the vertical line (Family 1 figure) need not have the same size radius as the quarter-loop at the bottom (Fig. 15). However, the top radius must not be “corner” or very sharp angle (Fig. 16). It must have a smooth, distinct, and constant radius.

5C.8. FAI “ARESTI Aerobatic Catalogue (Condensed)” Families:**5C.8.1: Family 1: Lines and Angles.**

Family 1.1.1 to 1.1.11 has been fully covered in the preceding section. Note that the figures in Family 1.2.1 to 1.2.16 are NOT performed as drawn in the “ARESTI Aerobatic Catalogue (Condensed)”. In each of these figures there are three looping components: a one-eight loop, a three-eight loop and a quarter loop. Rolls may be performed on the 45-degree line and/or the 90-degree line, with the part line being of equal length. The initial horizontal line and the line at the end of the figure may be flown at different altitudes (Fig. 17).

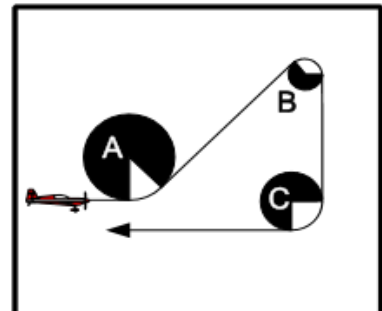
**Fig. 17**

Family 1.2.1 - 1.2.16 as flown radii A, B and C may all be different. Start and exit altitude may also differ.

5C.8.2: Family 2: Turns and Rolling Turns.

5C.8.2.1: Turns. In aerobatic competition, a turn is divided into three parts:

- 1: Establishing the bank using a roll on heading.
- 2: The turn itself.
- 3: A roll back to straight and level flight on heading.

Let's look at the turn during each of these three parts. First, the roll to establish the bank. This must be a roll of between 60 and 90 degrees; it must be performed on the entry heading; and the aircraft must maintain a constant horizontal line. Once the roll is completed and the angle of bank is established, the competitor

immediately performs the turn. The turn must maintain the established angle of bank throughout. The aircraft must also maintain horizontal flight. The rate of turn is constant throughout and the figure must be wind corrected so that, for instance, a 360-degree turn will be a perfect circle. It should be noted that the wind correction cannot be performed by visibly changing the bank angle.

As soon as the aircraft is on the exit heading, the competitor performs another roll at a rate equal to the entry roll. Again, the aircraft must maintain a constant horizontal line.

Downgrades:

a: The angle of bank established by the initial rolling manoeuvre must be at least 60 degrees and not greater than 90 degrees. Any less or more is a 0.5 point deduction for every 5 degrees.

b: The angle of bank, once established, must remain constant. Any deviation is a 0.5 point deduction for every 5 degrees of deviation.

c: The rate of roll must be the same for the entry and exit rolls of this figure. Any deviation is a one (1) point deduction.

d: The aircraft must maintain a constant altitude throughout the figure. Any variation would be 0.5 point deduction for every 5 degrees of change.

e: The rate of turn must remain constant. Any change would be not more than a one (1) point deduction for each change. Note that the rate of turn may appear to change in a strong wind, when it really isn't changing. The judges must always keep the wind in mind and give the pilot the benefit of the doubt if there is any question.

f: The aircraft must begin and end on the prescribed heading. Any deviation is a 0.5 point deduction for every 5 degrees of deviation.

5C.8.2.2: Rolling Turns

The rolling turn is a figure that combines a turn of a prescribed amount with a roll or rolls integrated throughout the turn. The rolls integrated into the turn may be in the same direction as the turn and are called "rolls to the inside" or may be in the opposite direction of the turn and are then called "rolls to the outside" (Fig. 18). There can also be rolls alternating in and out. The direction of these rolls, to the inside or to the outside, must be flown exactly as depicted in the ARESTI. When we say that the rolls are integrated, we are saying that in addition to there being constant rate of turn throughout the figure, there is also a constant rate of roll throughout. Naturally, the one exception to this constant roll rate is the pause when reversing roll direction. In addition, the entire manoeuvre is to be flown at a constant altitude.

To help visualise the execution of this figure and facilitate a way for the judges to determine a constant roll rate, let's look at an aircraft performing a 360 degree rolling turn with 4 rolls to the inside from upright (Family 2.4.7.1). First, on the prescribed entry heading, the pilot executes a turn and simultaneously initiates a roll in the same direction as the turn. The judges will expect the aircraft to be inverted at 45, 135, 225 and 315 degrees and to be upright at 90, 180, 270 and 360 degrees. At these interim headings, the judge will NOT downgrade using the 0.5 point for 5 degree rule but will judge changes in the rate of roll, changes in the rate of turn and changes in altitude. At the end of the 4 rolls, the aircraft must have terminated its 360 degree turn and finish at the same point where it started, wings level and on the prescribed heading.

When a rolling turn is performed with rolls alternating directions, the aircraft must change direction of roll at a wings level attitude. The position of the aircraft in the turn is still only used as an aid to determine if the pilot is varying the rate of roll or turn.

Downgrades:

a: Performing more or fewer rolls than the ARESTI description calls for, or rolling in a direction different than depicted on the ARESTI results in the figure being zeroed.

b: All rolls in a rolling turn are standard rolls. If a snap roll is performed, the figure will be marked zero (0).

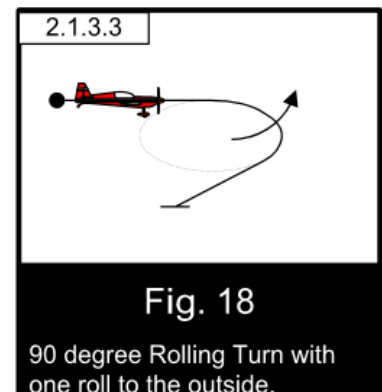

- c: Each stoppage of the rate of roll is a deduction of one (1) point.
- d: Each variation in the rate of roll is a one (1) point deduction.
- e: Each variation in the rate of turn is a one (1) point deduction.
- f: Variations in altitude are deducted using 0.5 points per every 5 degrees difference.
- g: 0.5 points per every 5 degrees that the aircraft is not in level flight when reversing roll direction.
- h: 0.5 points for every 5 degrees of roll remaining when the aircraft has reached its heading.
- i: 0.5 points for every 5 degrees of turn remaining when the aircraft has completed its last roll.

5C.8.3. Family 3: Combinations of Lines.

For all the figures in Family 3, (Three Corners, Four Corners, and Eight Corners) the transition from level flight to a 45 degree line should be at a constant and reasonable one eighth (1/8) looping radius. All lines within the figure should be equal in length. All part loops within the figure should be of identical radii. The 45-degree transitions in Family 3 should have a constant radius and not a sharp corner (Fig. 19). The basis for judging line length is the first line flown. Refer to rule 5C.7.1 for downgrades.

The radius of all part loops in the figure are measured against the first part loop flown in the manoeuvre. Thereafter, each part loop flown within the manoeuvre that has a different radius than the first part loop flown receives a one (1) point deduction.

Each part loop flown in the manoeuvre must have a constant radius. Each variation of radius within a part loop receives a one (1) point deduction.

5C.8.4: Family 4: Not in use.

5C.8.5: Family 5.2-5.4: Stall Turns.

Stall Turns, also referred to as “Hammerheads”, are some of the most graceful figures in the “ARESTI Aerobatic Catalogue (Condensed).” In its most basic form, the figure begins when the aircraft leaves horizontal flight and flies a one-quarter loop to establish a vertical climb or flies a one-eighth loop to establish a 45 degree up line. If the entry is a one-eighth loop to a 45 degree line then, having presented that line, the aircraft will fly another one-eighth loop and establish a vertical up line. At the top of the vertical line, the aircraft stops, pivots and establishes a vertical descent. The vertical line may terminate in a one-quarter loop which will return the aircraft to horizontal flight and end the figure. Or, after the vertical descent from the peak, the aircraft may fly a one-eighth loop to a 45 degree down line. Having presented this line, the aircraft will fly another one-eighth loop to return to horizontal flight thus ending the figure.

The judging criteria are:

- a: The up and down lines, vertical or 45 degree, must be wind corrected so that they are flown as a straight line at the correct angle to the horizon.
- b: On the up and down lines, any roll deviation, or deviation of the track of the aircraft in pitch or yaw will result in a deduction of 0.5 points per 5 degrees of deviation.

c: Any added roll element(s) on the vertical or 45 degree lines must be positioned so that the line segments before and after the roll elements are of equal length (Fig 21).

d: The length of the up and down lines, vertical or 45 degree need not be equal. Therefore, the altitude of the horizontal lines at the entry and exit of the hammerhead may be different and no downgrade applies for this difference.

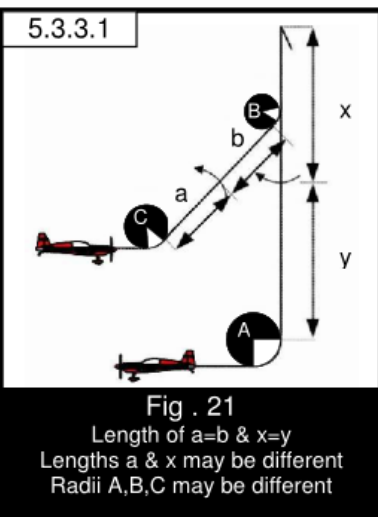
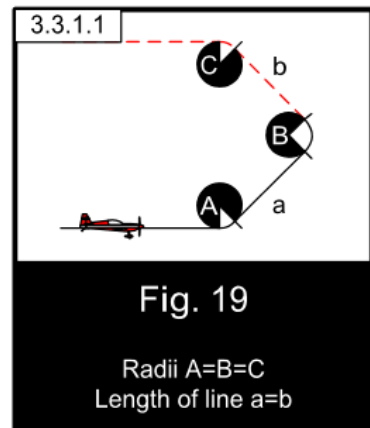

e: As the aircraft nears the point where it stops climbing, it must pivot in a plane parallel to vertical. Any alignment deviation from parallel to the vertical should be downgraded 0.5 points for each 5 degrees of deviation.

f: When the aircraft pivots at the top of the vertical line in a stalled or near stalled condition, no deduction should be applied for wind drift during that particular time.

g: In the case of strong cross winds, the aircraft will most probably be “crabbing” to wind correct the up and down lines. The pivot at the top of the line might therefore be less or more than 180 degrees and no downgrade should be applied to it.

h: Any pendulum movement observed after the pivot is subject to downgrade at 0.5 points per 5 degrees of movement off the vertical. This downgrade is applied for each movement either side of the vertical.

When rotating at the top of the manoeuvre, ideally, the aircraft pivots around its centre of gravity. To avoid a deduction, the aircraft must pivot around an axis point, which cannot be farther away from its centre of gravity on the vertical up line than its wingtip ($\frac{1}{2}$ wingspan). The downgrade for this deviation is one (1) point per half wingspan that the point of rotation exceeds the maximum allowed (Fig 22).

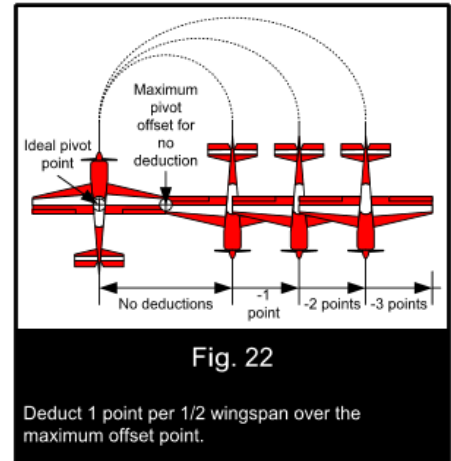

Judges must be careful to deduct only for true extended turnaround, and not for any apparent deviation caused by wind drift during the pivot. One way to recognize a “fly-over” from a wind drift will be that the “fly-over” is generally characterised by the continuation of vertical movement and a pivot larger than 4 wingspans. A “fly-over” Stall Turn should be marked zero (0) (Fig 23).

The manoeuvre should also be marked zero (0) if any distinctive backward sliding movement is observed before the start of the pivot, even if the rotation is correctly performed after the slide (Fig. 24). The rate at which the aircraft pivots around its vertical axis is not a judging criterion.

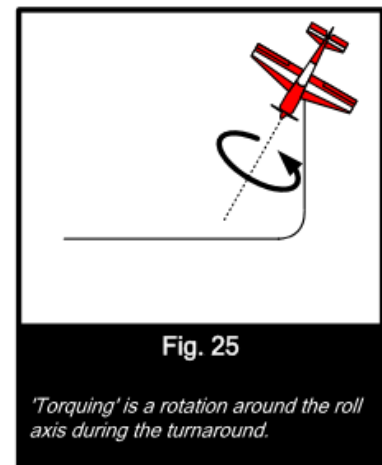
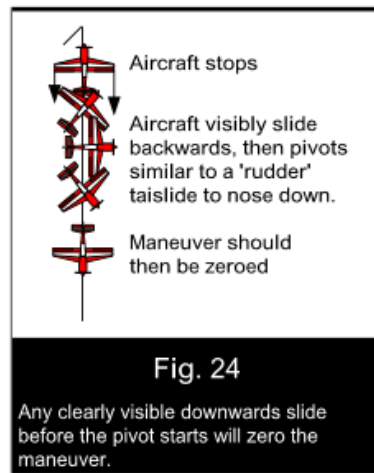
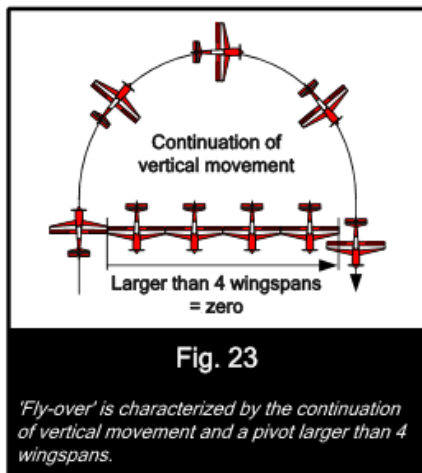

During the pivot, the wings must remain in the vertical geometric plane as dictated by the ARESTI. This alignment must be maintained throughout the pivot, and the aircraft’s attitude at the beginning and the ending of the pivot must be absolutely vertical. During the pivot there must be no deviation in pitch or roll. Any pitch and roll deviation observed during the pivot should be downgraded at 0.5 points for each 5 degrees of deviation. Such movement around the roll axis during the pivot is often referred to as “torquing” (Fig 25).

5C.8.6: Family 6.2: Two Line Tail Slides.

All the criteria of the Stall Turn apply to this figure except, of course, for the manoeuvre at the top of the vertical climb. At the point when the aircraft stops climbing, it must slide backwards a visible amount in the vertical plane. The key here is “visible” and “vertical plane.” If the aircraft pivots directly on the top, without any clearly visible slide, the manoeuvre should then be marked zero (0). Following the slide backwards, the aircraft must then tip over and fall through to a diving position. Often the nose will swing back or “pendulum” in pitch past the vertical after falling through.

The figure is not to be downgraded for this, nor downgraded if it does not happen. It is a function of the length of the slide and the type of aircraft, and is not to be considered in grading the figure.

There are two types of Tail Slides: wheels-down and wheels-up. The wheels-down Tail Slide is depicted in the ARESTI diagram with a curved solid line at the top of the Tail Slide symbol (Fig. 26). The wheels-up Tail Slide is depicted in the ARESTI diagram with a curved dashed line at the top of the Tail Slide symbol (Fig. 27).

This figure must be watched carefully, as the aircraft can fall the wrong way (which is graded a zero) with the correct direction of flight and the proper aircraft attitude still maintained.

The judging criteria are:

a: All lines and arcs flown in the figure are to be wind corrected and correctly aligned within the airspace as described in sections 5C.5.3, 5C.7.1 and 5C.7.2. Observed alignment deviations receive a deduction of 0.5 points for each 5 degrees of deviation.

b: Absence of any visible backward slide in the vertical plane zero's the entire figure.

c: On all up and down lines, the roll attitude must be perpendicular to the plane of the main axis of flight, either the X or Y axis. This includes the duration of the fall through. Watch for the aircraft torqueing off the correct plane of flight. Any deviation in roll should be downgraded at 0.5 points per five (5) degrees of deviation.

d: As with the Stall Turn, the aircraft will be in a stalled or near-stalled condition at the top of the vertical line and no deduction for wind drift should be applied during that particular time.

e: The altitude of the entry and exit horizontal lines need not be the same and the figure must not be downgraded if they are different.

f: When rolls are combined with Family 6 figures, the line segments before and after the roll(s) must be of equal length. Refer to rule 5C.7.1 for downgrades.

g: After performing the Tail Slide at the peak of the manoeuvre, the aircraft must establish a visible vertical down line. If this line is omitted, a downgrade of one (1) point is to be applied.

In summary, the aircraft should make a smooth and steady transition up to vertical flight, and the aircraft should come to a complete stop in this attitude. After sliding backward a visible amount, it should fall through in the appropriate direction without dropping a wing or the nose moving off axis, and recover on the same plane as that of entry. After completion of this, it should again project the 90-degree down line (wind corrected if required) before transitioning into horizontal flight.

5C.8.7: Family 7: Loops and Eights.

5C.8.7.1: General Principles:

Family seven figures are covered in the following sections in groups, sections 5C. 8.7.2 to 5C.8.7.8. Each section provides the manoeuvre description and the overall judging criteria for the group. Each section also provides, for the most part, the downgrades to be applied for deviations. However, some downgrades in some of the sections are not completely specified and, as such, are described here:

a. The size of a loop or part loop is not a grading criterion. It will vary according to the flight characteristics of the aircraft. A large loop is not graded any higher or lower than a small loop, but any variation to the radius will downgrade these figures.

b. All radii are to be constant. Each visible variation in the radii in a loop or part loop is to be downgraded by one (1) point.

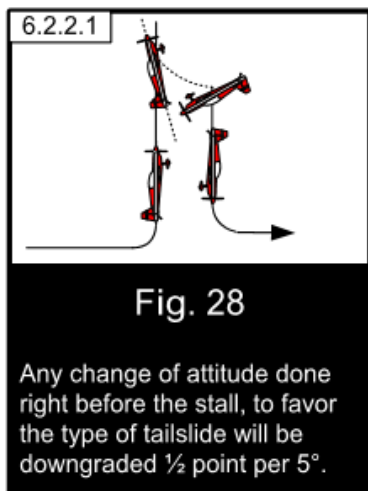
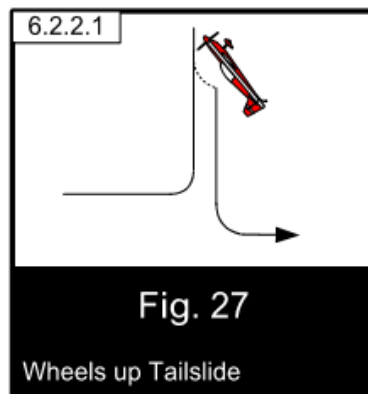
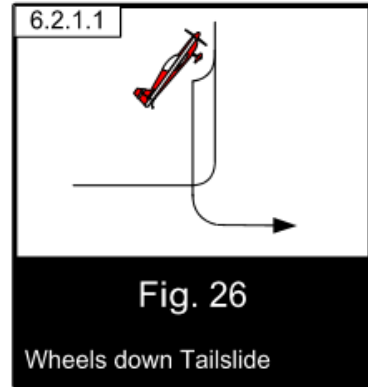

c. Where radii of part loops within these figures are required to be the same and they are not, a downgrade of one (1) point is to be applied for each mismatch. The standard is the first part loop flown within the figure.

d. Where complete loops or part loops within these figures are required to be the same size and they are not, a downgrade of one (1) point per mismatch is to be applied.

e. Roll elements that are to be done on a line must be centred and are to define two equal length line segments, one either side of the roll element. Refer to rule 5C.7.1 for downgrades.

f. Where a roll element is to be done entering or exiting a part loop there is to be no line shown between the part loop and the roll element. The downgrade for showing a line in these situations is a minimum of two points.

g. Where a roll element is to be done on a line between two vertical half loops, or between two full loops that form a vertical eight, and the line is absent, a downgrade of two (2) points is to be applied. There are to be no lines before or after the roll element and, if present, each such added line should result in a two (2) point deduction.

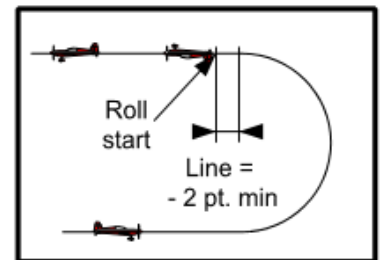

Fig. 29

Drawing a line after the 1/2 loop is a minimum downgrade of 2 points.

5C.8.7.2: Family 7.2: Half Loops

The half-loops in this sub-family must be of a constant radius and wind-corrected to appear as a perfect half circle (see full loop discussion below). When a half-loop is preceded by a roll or rolls, the half-loop follows immediately after the roll(s) without any visible line. Drawing a line requires a downgrade of at least two (2) points depending on the length of the line drawn. Should the half-loop begin before the roll is completed, the judge must downgrade the figure 0.5 points for every 5 degrees of half-loop flown on which the roll was performed.

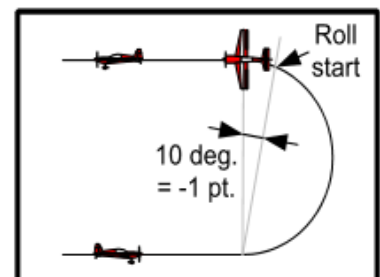

Fig. 30

Aircraft starting the roll ten degrees early before reaching horizontal flight = - 1 point

The half-loop followed by a roll is also flown with no line between the half-loop and roll. Again, drawing a line requires a downgrade of at least 2 points depending on the length of the line drawn (Fig. 29). Should the roll begin before the half-loop is completed, the judges must downgrade the figure 0.5 points for every 5 degrees of half-loop on which the roll was performed (Fig. 30). Great care should be taken here to differentiate between aircraft airfoils and the slow speed at the top of the half loop + roll manoeuvre. The aircraft will appear to begin the roll before reaching horizontal flight due to its high pitch attitude. As the aircraft accelerates, it will then establish a cruise pitch attitude.

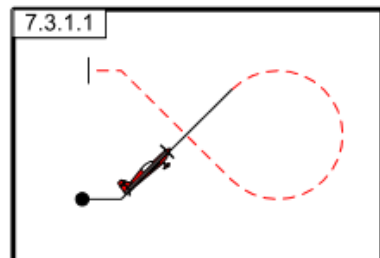

Fig. 31

Three-Quarter Loops or "Goldfish"

5C.8.7.3: Family 7.3: Three-Quarter Loops

Sometimes referred to as "Goldfish" (Fig 31), the lines are judged with reference to the 45 degree flight path. Any rolls on the 45 degree lines must be centred on that line. It is not required that the lengths of the 45 degree lines bear any strict relation to the diameter of the three-quarter (3/4) loop. That is, the entry and exit altitudes do not need to correspond to the altitude limits of the loop.

5C.8.7.4: Family 7.4: Whole Loops

5C.8.7.4.a: Round Loops (7.4.1 – 7.4.2)

All whole round loops must appear perfectly round to the judge (Fig 33). If required, they must be wind corrected to have a constant radius. This wind correction is not only with regards to the roundness of the loop but also for the effect of any crosswind on the figure. Therefore, a standard deduction of 0.5 points per five (5) degrees should be applied if the finish point is displaced in a direction perpendicular to the plane of the loop (Fig. 34). In a heavy crosswind situation, a loop might be flown with visible crabbing and no deduction should be applied in this case.

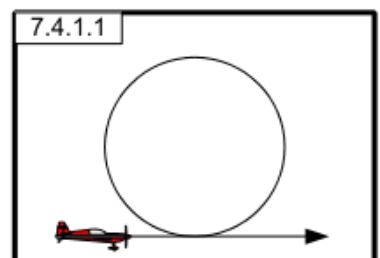
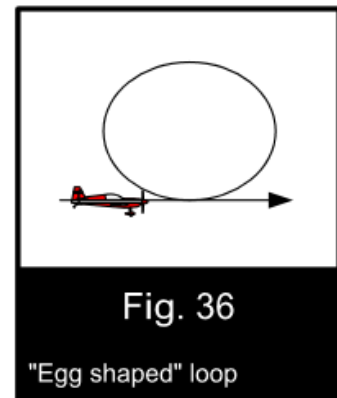
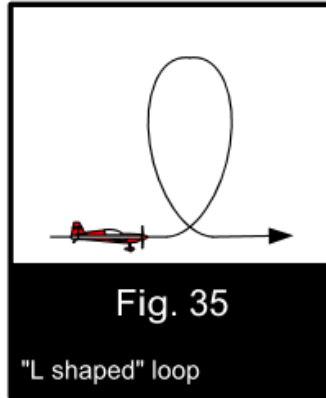
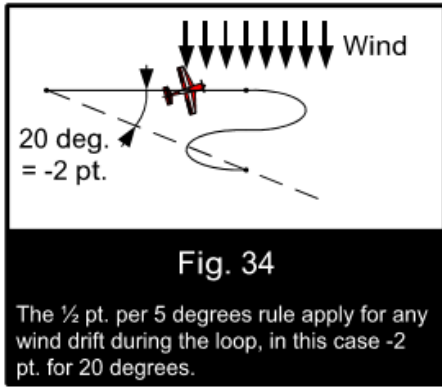

Fig. 33

Full loops must appear perfectly round to the judges.

To better quantify deductions for loops, the judges should watch for these irregularities: perpendicular displacement, change of radius, aircraft roll and flat spots (aircraft without a flight path radius) within the loop.



Deductions are as follows:

- a. As stated in first paragraph, 0.5 points per five degrees for perpendicular displacement.
- b. A variation in the radius will be a one point deduction per occurrence.
- c. Aircraft displaying any roll other than during a roll element on the loop, 0.5 point per five degrees of roll.
- d. Flight path without any radius (straight line or "flat spot"), one point per occurrence.

In judging loops, a common error is for the vertical diameter of the loop to be larger than the horizontal diameter. This is often called an "L" shaped loop (Fig. 35). Less common are loops with a horizontal diameter greater than the vertical. This is called an egg-shaped loop (Fig. 36).

Another common error is in varying the radius of the final quadrant performing an "e" shaped loop (Fig. 37). The downgrades listed above should be applied for each of these errors.

If there is a rolling element (roll, point rolls or snap roll) at the apex of the loop, it must be centred in the loop and flown on the arc of the loop itself (Fig. 38). Flying the roll on a line at the apex of the loop is at least a two (2) point downgrade. If the roll is not centred, it must be downgraded 0.5 points for every five degrees that it is off centre.

5C.8.7.4.b: Family 7.4.3- 7.4.6: Square, Diamond and Octagon Loops

Square and Octagon loops are flown as hesitation loops with lines of equal length and partial loops with equal radii (Fig. 39). Square and Octagon loops are not considered complete until the last horizontal line is drawn equal to the length of the first line of the figure.

All horizontal, vertical, and 45-degree lines are judged on flight path and should therefore be wind corrected. As such, the judge should always expect to see these figures closed, the same way as a round loop.

Where rolls are flown on the Square or Diamond loops, they must be centred on the line. Aids for judging all hesitation loops are that a good performance will contain changes of angular velocity in all the partial loops, and variations of time taken to draw the length of each interior line, which also varies according to the aircraft's speed. The rhythm of all these partial loops is a help for judging.

cont.../

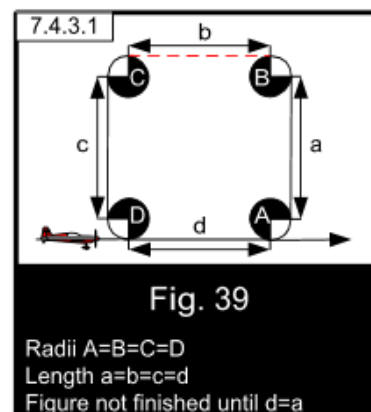
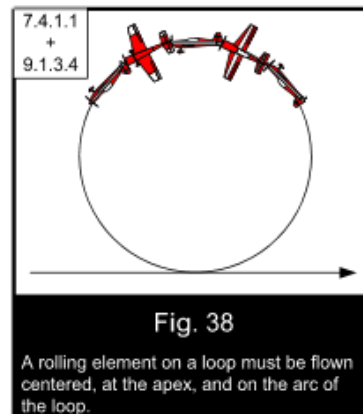
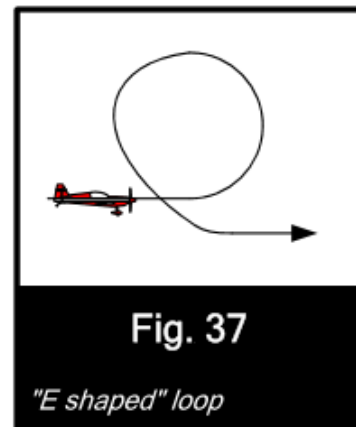

5C.8.7.4c: Family 7.4.7-7.4.14 Reversing Whole Loops

Reversing Whole Loops shall be judged using the same criteria for Whole Loops. No line is to be flown between the $\frac{1}{4}$ and $\frac{3}{4}$ loop segments, and the radii of all loop segments must be equal (Fig 39a). Drawing a line between the loop segments requires a downgrade of at least two (2) points depending on the length of the line drawn. Rolls placed either before or after the Reversing Whole Loop shall be flown with no line segment between the roll and the loop. Drawing a line requires a downgrade of at least two (2) points depending on the length of the line drawn. Any rolling element flown at the apex (top of loop) or bottom of the loop shall be judged in accordance with the rules for Whole Loops found in paragraph 8.7.4.a.

5C.8.7.5a. Family 7.5.1-7.5.8: Horizontal “S”s

Horizontal “S”s may be described as two Half Cubans joined together, sharing a common 45 degree line. In these figures, both $\frac{5}{8}$ ths loops must have the same radii (Fig 39b). When the looping portion of the figure is immediately preceded by (on entry) or followed by (on exit) a roll or rolls, there must be no visible line between the roll and loop elements. Drawing a line requires a downgrade of at least two (2) points depending on the length of the line drawn. This criterion is not meant to imply that one element (roll or loop) must start before the preceding element is completely finished. A brief hesitation between elements (similar to opposite rolls) should not be downgraded.

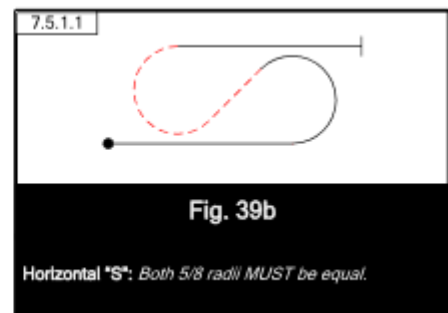
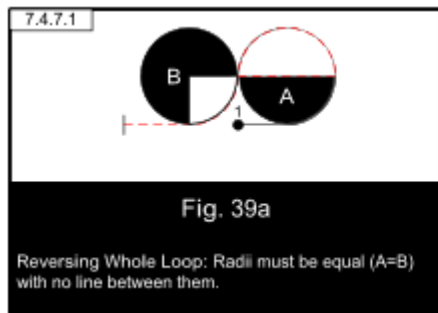

Any rolls that are placed on the 45-degree line (between the two $\frac{5}{8}$ ths looping portions) must be centred on the line, and do not follow or precede the looping portions as described above.

5C.8.7.5b. Family 7.5.9-7.5.10: Vertical “S”s

These figures are accomplished with two joined half-loops flown in opposite directions (Fig. 40). Look for both half-loops to be the same size and perfectly round. The half-loops should be a continuous looping figure when there is no half roll between the half-loops. When a half roll is performed between the half loops (full roll(s) are not authorized), there is no line before or after the half roll. However, the half roll is flown on a horizontal line which begins as soon as the first half-loop is finished. As soon as the half roll is finished, the next half-loop must begin immediately (Fig. 41). Adding a line at either of these points is at least a two (2) point deduction, depending on the length of the line.

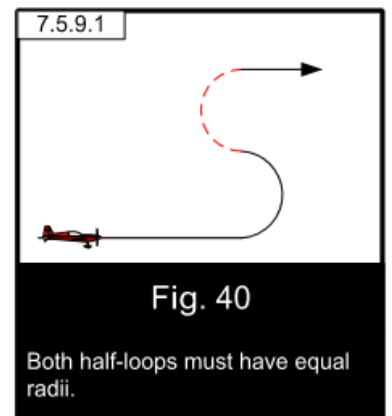

5C.8.7.6: Not in Use

5C.8.7.7: Not in Use

5C.8.7.8a: Family 7.8.1 - 7.8.8: Horizontal Eights

Also referred to as “Cuban Eights,” the $\frac{5}{8}$ ths and $\frac{3}{4}$ loops must have the same radii; lines between the loops flown at exactly 45 degrees (Fig. 42). Wind correction shall be applied throughout the figure so that the 45-degree lines intersect at the exact mid-point of the Horizontal Eight. If there are roll elements on the 45 degree line(s), they will be positioned so that the lines before and after the roll are of equal length.

When the $\frac{5}{8}$ ths loop portion is preceded or followed by a roll element, there must be no visible line between the roll element and the $\frac{5}{8}$ ths loop. Inserting a line between the roll element and $\frac{5}{8}$ ths loop portion requires a minimum downgrade of 2 points.

The start and finish of the figure and the bottoms (or tops if reversed) of the $\frac{5}{8}$ ths and $\frac{3}{4}$ loops must be at the same altitude.

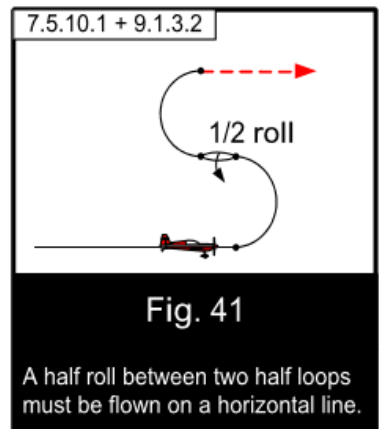

The radius of the 1/8 loop between the 45 degree line and horizontal flight need not equal the radii of the 5/8ths and 3/4 loops of the Horizontal 8.

5C.8.7.8b: Family 7.8.9 - 7.8.16: Horizontal Super “8”s

Besides possessing the unique characteristic of containing three 45-degree lines on which rolls may potentially be placed, this family can be thought of as two linked Three-Quarter Loops (Family 7.3).

The radii of the two 3/4 loops must be identical to each other. Each of the 45-degree lines may be of different lengths, but any rolls placed on them must be centred. The two 3/4 loops need not occur at the same altitude, nor is there any relationship between the horizontal entry/exit altitude and the altitude limits of the two 3/4 loops (Fig. 43).

5C.8.7.8c: Family 7.8.17 – 7.8.22: Vertical “8”s

These figures are performed by flying two loops, one above the other (Fig. 44).

Sub-family 7.8.17-7.8.20 is composed of two loops, both above or both below the entry altitude. Sub-family 7.8.21 - 7.8.22 is composed of one loop above and one loop below the entry altitude. In case, the entry and exit altitude must be the same.

These figures may be combined with various types of half rolls. When a half roll is performed between the loops, there is no line before or after the half roll. However, the half roll is flown on a horizontal line that begins as soon as the first loop is finished. As soon as the half roll is finished, the next loop must begin immediately. Adding a line at either of these points is at least a two (2) point deduction depending on the length of the line. These figures are to be graded using the same criteria as full loops. Additionally, both loops must be of the same size. Unless there is a half roll between the loops, they must be directly above one another. Here as well, the beginning and the end point of the manoeuvre will not be in the same vertical plane if a half roll is flown between the loops (Fig. 45). This should not be a reason for downgrade.

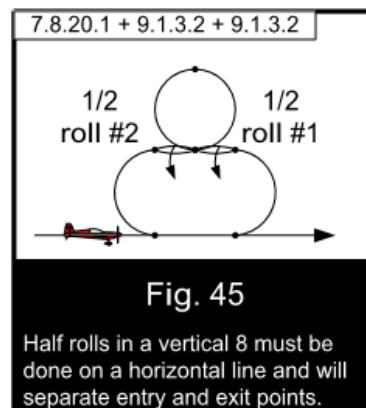
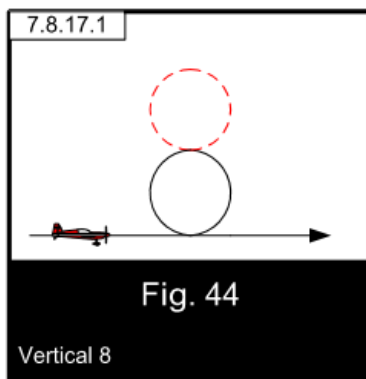
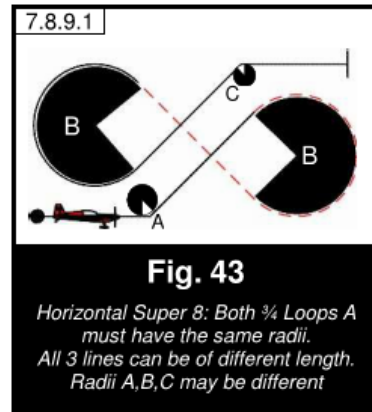
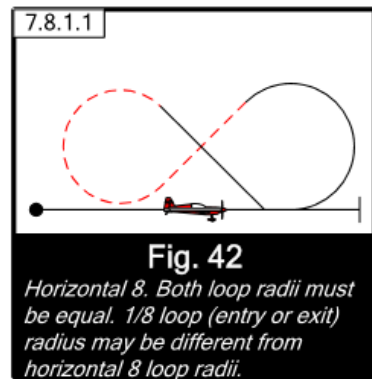

5C.8.8: Family 8: Combination of Lines, Loops, and Rolls

5C.8.8.1 – General Principles:

Family 8 figures are covered in the following sections. Each section provides the manoeuvre description and the overall judging criteria for the group. Each section also provides, for the most part, the downgrades to be applied for deviations. However, some downgrades in some of the sections are not completely specified and, as such, are described here.

a. The size of a loop or part loop is not a grading criterion. It will vary according to the flight characteristics of the aircraft. A large loop is not graded any higher or lower than a small loop, but any variation to the radius will downgrade these figures.

b. All radii are to be constant. Each visible variation in the radii in a loop or part loop is to be downgraded by one (1) point.

c. Where radii of part loops within these figures are required to be the same and they are not, a downgrade of one (1) point should be applied for each mismatch. The standard is the first part loop flown within the figure.

d. Roll elements that are to be done on lines must be centred and are to define two equal length line segments either side of the roll element. Refer to rule 5C.7.1 for downgrades.

e. Where a roll element is to be done entering or exiting a part loop there is to be no line shown between the part loop and the roll element. The downgrade for showing a line in these situations is a minimum of two points. This criterion is not meant to imply that one element (roll or loop) must start before the preceding element is completely finished. A brief hesitation between elements (similar to opposite rolls) should not be downgraded.

5C.Sections 8.8.1 to 8.8.3: Not in Use.

5C.8.8.4.1: Family 8.4.1 - 8.4.28: Humpty Bumps and Diagonal Humpty Bumps.

These figures, whether vertical or performed with 45-degree lines, are judged as combination of lines and loops. Half loop must still have a constant radius from the time they depart the vertical or 45-degree line. This requires a change in angular velocity during the half loop. The lines in these figures may be of different lengths, and therefore the entry and exit altitudes of these figures can be different. Rolls on any of these lines must be centred (Fig.46).

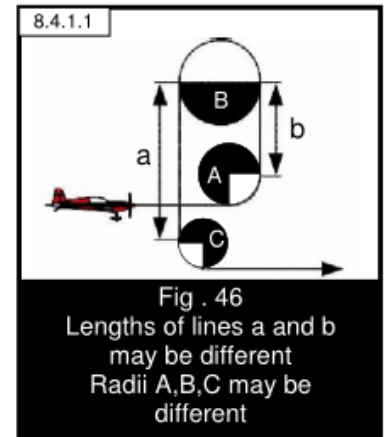

5C.8.8.5: Family 8.5.1-8.5.24: Half Cubans and Vertical 5/8ths Loops.

In these figures, when the looping portion of the figure is immediately preceded or followed by a roll or rolls, there must be no visible line between the roll and loop elements. The rolls on vertical and 45-degree lines must be centred, except for roll(s) following a spin. Angles drawn in the “ARESTI Aerobatic Catalogue (Condensed)” (Fig. 47), are to be flown as partial loops. No such part-loop is required to match the radius of any other part loop depicted in the same figure.

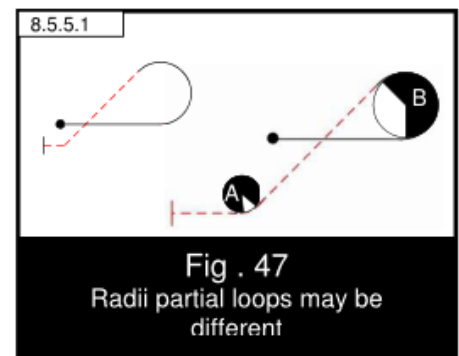

5C.8.8.6: Family 8.6: “P” Loops and Reversing “P” Loops

When 1/4, 1/2 or 3/4 loops join each other in these sub-families, the radii must be equal and there is no line between the loops. Inserting a line between joined loop segments requires a minimum two (2) point deduction depending on the length of the line (Fig. 49).

Roll elements on the vertical line must be centred.

Roll elements at the apex of the loop must be centred in the loop and flown on the arc of the loop. Flying the roll on a line at the apex of the loop is at least a two (2) point downgrade. If the roll is not centred, it must be downgraded 0.5 points for every five degrees that it is off centre.

When a loop portion is preceded or followed by a roll element, there must be no visible line between the roll element and the loop portion. Inserting a line between the roll element and loop portion requires a minimum downgrade of 2 points.

The 1/4 loop to or from horizontal flight should have a reasonable radius, but need not match the other looping radii (fig.48a).

cont/...

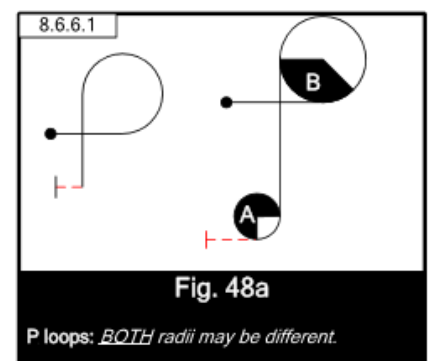
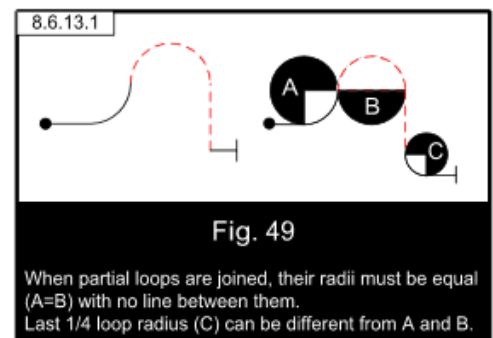

5C.8.8.7: Family 8.7: 7/8ths loops

Sometimes called “Q Loops”, these figures consist of a 7/8ths loop with either a 45 degree entry or exit line. The 1/8th loop to or from the 45 degree line should have a reasonable radius, but need not match the radius of the 7/8ths loop. (fig.49b)

Roll elements on the 45 degree line must be centred. Roll elements at the apex of the 7/8ths loop must be centred on the loop and flown in the arc of the loop. Flying the roll on a line at the apex of the loop is at least a two (2) point downgrade. If the roll is not centred, it must be downgraded 0.5 points for every five degrees that it is off centre.

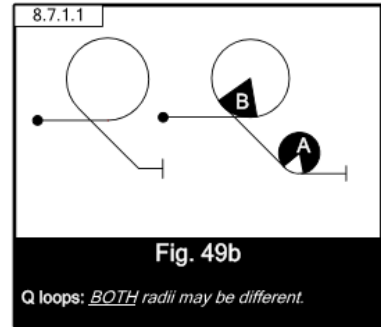

When the 7/8ths loop is preceded or followed by a roll element, there must be no visible line between the roll element and the loop. Inserting a line between the roll element and 7/8ths loop requires a minimum downgrade of 2 points.

Note: for certain types of “Q” Loops in this family, rolls are not allowed at the apex of the 7/8th loop (for example, figures 8.7.x.3 and 8.7.x.4).

5C.8.8.8: Family 8.8: Double Humpty Bumps

These figures are generally judged using the same criteria as Single Humpty Bumps (see section 5C.8.8.4.1). The two half-loops are not required to match each other, nor are they required to match the entry/exit loop radii. As with Single Humpty Bumps, the entry and exit altitudes need not be equal (Fig.49a).

5C.8.8.9: Not in Use

5C.8.8.10: Family 8.10: Reversing 1 ¼ Loops

The ¾ and ½ loops in these sub-families must be the same size and are flown as continuous segments with no line between the loops. Inserting a line between joined loop segments requires a minimum two (2) point deduction depending on the length of the line.

Roll elements on the vertical line must be centred.

When the ¾ loop is preceded by a roll element, there must be no visible line between the roll element and the loop portion. Inserting a line between the roll element and loop portion requires a minimum downgrade of 2 points.

The final ¼ loop to horizontal flight should have a reasonable radius, but need not match the other looping radii.

5C.8.9: Family 9: Rotational Elements

Rolls (9.1 - 9.10) may be performed on horizontal, 45-degree or 90-degree lines, on complete loops, between part-loops, between part-loops and line, and following spin elements. They may be ¼, ½, ¾, or a full 360 degrees in their rotation, up to two consecutive full rolls. Additionally, rolls may be flown in combination with turns as prescribed in Family 2 (Rolling Turns). In all cases, the same criteria apply: The rate of roll must be constant throughout the roll(s). The aircraft should continue to project, during the rolling portion, the prescribed plane and direction of flight.

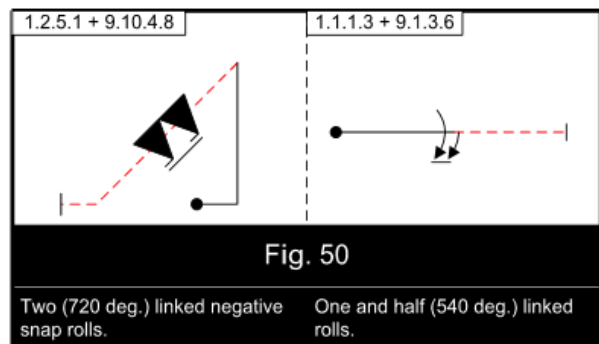

Multiple rolls may be linked, unlinked or opposite:

a: When rolls are in continuous rotation, the tips of the symbols are linked by a small line. When flying linked rolls, there is no pause between them (Fig. 50). Should there be one; the figure should then be marked zero (0).

b: Unlinked rolls must be of different types, the two types being defined as follows:

Type I: Aileron rolls (rolls and point rolls)

Type II: Snap rolls (positive and negative) – also referred to as “Flick Rolls”.

No line links the symbols, though their tips are drawn pointing in the same direction (i.e. on the same side of the line). Unlinked rolling elements must show a brief but perceptible pause between the elements that comprise the rolling combination. Absence of a perceptible pause between elements of the combination shall be downgraded by 1 point. This downgrade applies if the direction of rotation is required to be the same or opposite. (Fig. 51)

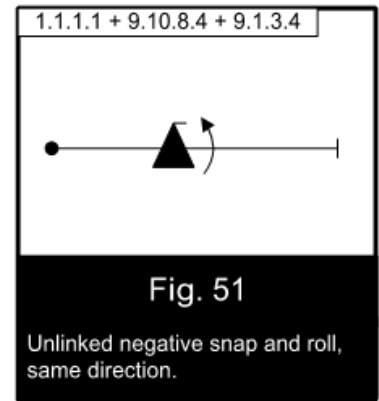

c: Opposite rolls may be either of the same or different type. In opposite rolls, the tips of the symbols are drawn on opposite sides of the line, indicating they are to be flown in opposite directions of rotation. The pilot may elect to fly the first roll in either direction, but the second roll must be the opposite direction to the first. Opposite rolls, including those in rolling turns should be flown as one continuous manoeuvre - the brief pause between opposite rotations should be minimal (Fig. 52). If the two rolls are of the same type, they must be flown in opposite direction if they are not linked.

d: Either aileron rolls or snap rolls may follow spin elements (Family 9.11 or 9.12). A spin and a roll combined on the same vertical downline will always be unlinked. They may be flown either in the same or opposite direction, as shown by the position of the tips of the symbols on the ARESTI diagram. The spin will always be the first element with a maximum of two (2) turns. It can be followed by a second rotational element like a roll or a snap roll also limited to a maximum of two (2) turns (Fig. 53). Adding a third rotational element will make the manoeuvre illegal, i.e. a one turn spin combined with one opposite roll and one opposite half roll (Fig. 54).

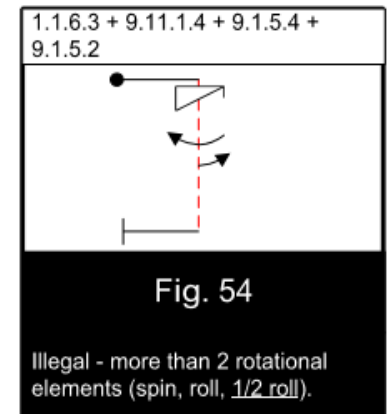
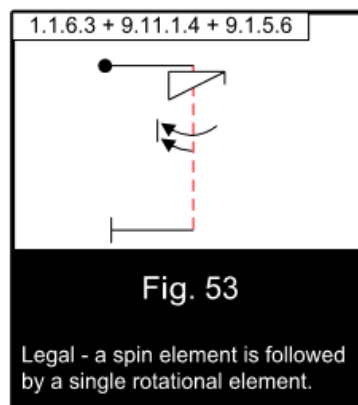
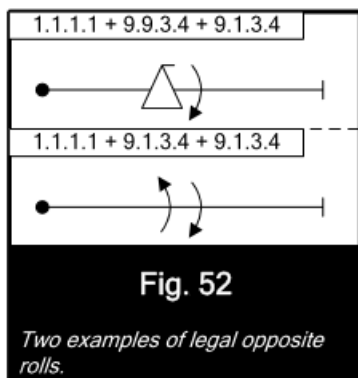

5C.8.9.1: Family 9.1: Rolls

The penalty for varying the rate of roll is one (1) point per variation. Any stoppage in the roll that could result its being considered a point roll would grade the figure zero (0).

The finish of the roll must be as crisp and precise as possible. Coming to a slow finish in fact represents a change in the rate of roll and should be penalised accordingly.

The wing must stop precisely after the desired degree of rotation and not go past the stop point and then return. This is referred to as “bumping the point” and a deduction of 0.5 points per 5 degrees shall be given in this case.

5C.8.9.2: Family 9.2 - 9.8: Point Rolls. Point Rolls

These rolls are judged on the same criteria as the standard roll, only the aircraft stops rotation during the roll for a pre-stated number of times, i.e. 2, 4, or 8. The rate of the roll and the rhythm of the points must be constant throughout with the aircraft projecting the pre-stated plane and direction of flight.

The pauses will be of identical duration and the degree of rotation between each pause shall be 180 degrees, 90 degrees, or 45 degrees, as depicted by the Aresti diagram. Each visible variation in the duration of the pause segments is downgraded by one (1) point. Errors in degrees of rotation (under / over rotating the points) are downgraded at a half (.5) point per five (5) degrees.

The roll rate of the rolling segments must be constant with each roll segment matching that of the preceding segment. Any visible deviation in roll rate from one segment to the next, or within a segment, is to be downgraded by one (1) point per occurrence.

The duration of the rolling segments as compared to the pause segments need not be equal. Each pause of a point roll must be clearly recognisable in every case. If a pause is not recognisable or is omitted, the figure is graded a zero (0).

5C.8.9.3: Family 9.9: Snap Rolls (“Flick Rolls”)

Snap rolls may be positive (pitch to the canopy) or negative (pitch to the wheels). Other than this difference, all judging criteria are the same for either type of snap.

Snap rolls are difficult to judge due to the speed of the snaps and the variation in the manner in which different aircraft perform snaps. However, two things must be present in order that a judge can decide that a snap roll has occurred. They are:

- The nose must pitch in the correct direction as indicated by the ARESTI figure (Fig. 55 & 56).
- Autorotation must be initiated.

Given the high energy nature of the snap, it is very difficult to tell if these two items are occurring simultaneously or sequentially. Therefore, there is no requirement that these two movements start simultaneously. They may occur simultaneously or sequentially in the order presented.

The requirements and downgrades that apply to snap roll elements are:

a. The snap must be done in the correct direction, positive or negative. If done in the wrong direction the manoeuvre is to be zeroed. Judges must watch very carefully for this as, due to the speed of the snap, it is very possible to miss an incorrect direction of the pitch.

b. There must be departure in the pitch axis in the required direction of the snap. Without some displacement in pitch there can be no high speed stall and therefore, there can be no snap. Aerobatic aircraft with very high rates of roll can occasionally fool a judge and present an aileron roll in place of a true snap. The movement of the aircraft’s nose in pitch departing the flight path is a necessary clue to the proper execution of snap rolls. As always, the competitor is given the benefit of the doubt, but if a judge is certain that a proper snap roll has not been executed, a zero (0) is to be given.

c. Autorotation must be initiated either simultaneously with the pitch departure, or immediately subsequent to it. No downgrade is to be applied if these two motions occur sequentially in the order just stated. Autorotation is difficult to discern but a definite clue is that there will be a yaw component to the rotation. Lacking any visible yaw, the aircraft will be rotating only on its roll axis and not presenting a true snap. As always, the competitor is given the benefit of the doubt, but if a judge is certain that autorotation is not present and therefore that a proper snap roll has not been executed, a zero (0) is to be given.

d. Any rotation / roll observed prior to the required pitch movement is to be downgraded 0.5 points for each 5 degrees of such rotation.

e. In the event that the start of autorotation is delayed somewhat after the required pitch movement has been shown, it is possible that the aircraft will draw a visible line between the pitch and the start of autorotation. If this occurs, the manoeuvre should be graded zero (0).

f. Autorotation, once initiated, must be maintained to the prescribed finish point of the snap roll. Coming out of autorotation early and aileroning to the end of the snap is a common error. In this case, a downgrade of 0.5 points for each 5 degrees is to be applied for the amount of rotation remaining at the point the autorotation ends, i.e., for however much the pilot ailerons to the finish. If the autorotation ends with more than 90 degrees of rotation remaining, even if the roll is completed with aileron, the snap roll is to be graded zero (0).

g. Alignment during the snap will vary from the prescribed line of flight due to the yaw displacement that is characteristic of a proper snap. This variation may be very small. However, immediately on completion of

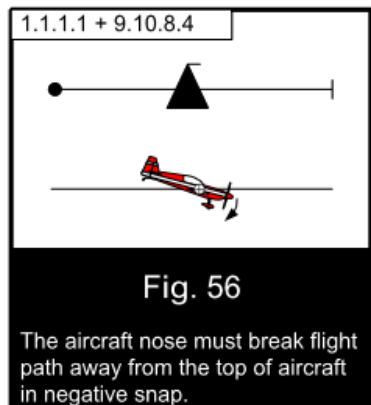
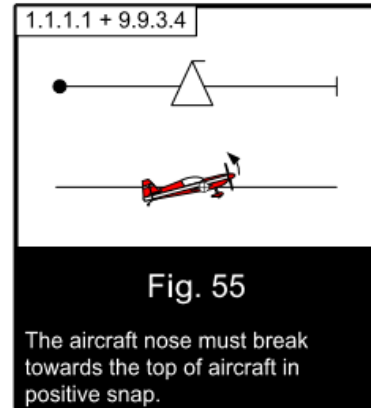

autorotation, the aircraft must be realigned with the prescribed line of flight. This will put the aircraft on a parallel but offset line or arc from that being flown prior to entry to the snap. If the aircraft exit from the snap is a line or arc that is identical to the entry line this is a clue that a proper snap was not executed. Again, the offset of the snap exit line or arc from snap entry line or arc may be very small but should be there. No penalty is to be applied for the offset or the realignment of the aircraft immediately after autorotation is completed. Lacking that realignment the extension of the snap exit line will be misaligned and that should be downgraded at 0.5 for each 5 degrees of misalignment from the prescribed line of flight in pitch, roll and yaw. "Line of flight" as just used here includes arcs.

5C.8.9.5: Family 9.11 - 9.12: Spins

Spins may be positive (entered from upright flight) or negative (entered from inverted flight). Other than this difference all judging criteria are the same for either type of spin.

Spin elements may be included in a number of Family 1 and Family 8 figures (where so indicated by the optional spin symbol in the ARESTI catalogue). All spins begin from horizontal flight with a defined entry line. This entry line to the spin is to be judged and downgraded as required in the same manner as any other wind corrected horizontal line. The only exception to judging the entry line is if the spin entry line is also the entry to the sequence. In this instance, the entry line is not judged and judging begins at the spin stall break. It should be noted that the flight path of the spin entry line should remain constant and not be influenced by the change of pitch attitude required to achieve the stall (Fig. 57), i.e., judge the track.

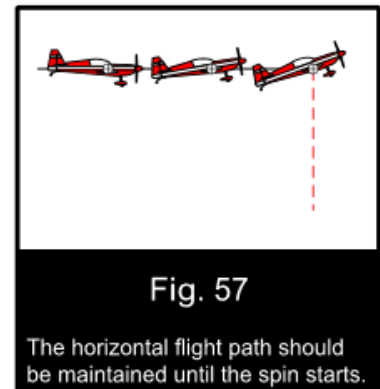

When the aircraft stalls, the nose will fall and at the same time a wing tip will drop in the direction of the spin initiating autorotation. The fall of the nose and the drop of the wing are to occur simultaneously. Failure to achieve this is to be considered a "late entry" and is to be downgraded. After completion of the prescribed number of turns, the aircraft must stop rotating precisely on the prescribed heading and then a wind corrected vertical down line must be shown. If a roll element follows a spin, there should be a brief, but perceptible pause (similar to unlinked rolls) between the spin and the roll. Because there is no vertical line before the spin, there is no criterion to centre a roll element that follows the spin on the vertical down line. No account is to be taken of the pitch attitude of the aircraft during autorotation, as some aircraft spin in a nearly vertical pitch attitude while others may spin in a somewhat flat attitude. Given these varying attitudes some aircraft may require a visible downward movement in order to set the aircraft into position to fly the required vertical downline after completion of autorotation. No downgrade is to be applied for this downward nose movement. Also, the speed of autorotation is not a judging criterion.

The requirements and downgrades that apply to spin elements are:

a. The entry line to the spin is a wind corrected line and any deviation in pitch, roll or yaw is to be downgraded at 0.5 points per each 5 degrees of misalignment. However, be sure to judge the track and not the attitude.

b. At the point of stall, the wings are to be level and any deviation in roll will be downgraded at 0.5 degrees for each 5 degrees of deviation. However, at this point in the spin element, when the aircraft is stalled or near stalled, no penalty should be applied for deviation in yaw due to wind. Also, due to wind the yaw attitude of the aircraft relative to the prescribed degree of rotation may result in actually rotating more or less than prescribed (Fig. 58). No penalty is to be applied for this variation provided it results from the effect of wind on the spin entry.

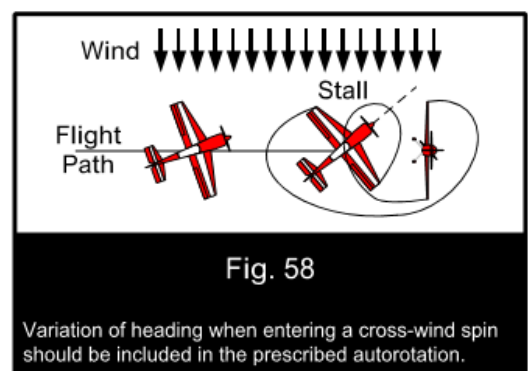

c. There must be a stall in order to have a proper spin. As always, the competitor is given the benefit of the doubt, but if a judge is certain that no stall occurred, a zero (0) is to be given.

d. The stall and the wing drop that indicates the start of auto rotation are to occur simultaneously. If they do not occur simultaneously, a downgrade of 0.5 points for each 5 degrees of movement that occurs in one movement before the other movement is shown, e.g., if the nose drops 20 degrees before the wing drop is shown a 2 point penalty is applied.

e. Starting the spin rotation in the wrong direction of rotation with a subsequent correction that forces the aircraft into the proper direction of rotation is to be penalised. Rotation movement in the incorrect direction is to be downgraded at .5 point for each 5 degrees of incorrect rotation.

f. The rotation in a spin must be autorotation which can be difficult to discern. A clue to making the judgment on "autorotation or not" is that autorotation will have a visible yaw component to the rotation. Absent this yaw component, it is probable that the aircraft is in some kind of an aileron roll. If a judge is certain that no autorotation occurred, a zero (0) is to be given.

g. The spin element must complete precisely at the degree of rotation called for by the ARESTI and not be short or beyond the prescribed end point of the rotation. Any deviation is to be downgraded 0.5 points per 5 degrees that the aircraft completes the spin short or long of the prescribed stopping point. Note that autorotation must carry to completion. It is common to see a pilot come out of autorotation early and aileron to the finish of the spin. If this occurs a penalty of 0.5 points per 5 degrees is to be applied for the amount of "aileroning" used to complete the required rotation.

h. Upon completion of the prescribed degree of rotation a vertical down line is to be shown. Omission of this line is to be downgraded one (1) point. Note that roll or snap elements may be called for on this down line after a spin. If they are called for, no centring requirement applies to the placement of these elements on this down line.

5.9. CLASS F3P – RADIO CONTROL INDOOR AEROBATIC AIRCRAFT

Class F3P contains F3P-Aerobatics (schedules F3P-AA, F3P-AP and F3P-AF) and F3P-AFM, Aerobatics Freestyle to Music.

F3P-AP/AF and F3P-AFM will be flown in Category 1 events.

5.9.1 Definition of an R/C Indoor Aerobatic Aircraft

A model aircraft, but not a helicopter, which is aerodynamically manoeuvred in attitude, direction, and altitude by a pilot on the ground using radio control. Variable thrust direction of the propulsion device(s) is not allowed except for F3P-AFM.

General Characteristics of Radio Controlled Aerobatic Model Aircraft shall be verified in processing procedures as per FAI Sporting Code, Section 4, Volume CIAM General Rules, for each participating model aircraft prior to a competition. Not permitted equipment must not be installed.

5.9.2 General Characteristics of R/C Indoor Aerobatic Aircraft

Maximum overall span 1500 mm

Maximum overall length 1500 mm

Maximum total weight, with batteries 300g

External parts that protrude which could be considered dangerous, (ie landing gear struts, shaft tips etc) must be covered in order to avoid injuries.

- a) A tolerance of 1% will be allowed for possible inconsistencies in measurement instruments for size, weight unless otherwise stated.
- b) Power device limitations: any suitable power device may be utilised except those generating any kind of exhaust emission.
- c) The propulsion device(s) must automatically shut-off or fully idle at the moment an R/C signal failure occurs.
- d) Radio equipment shall be of the open loop type (ie no electronic feedback from the model aircraft to the ground except for the stipulations in CIAM General Rules C.16.2.3). Auto-pilot control utilising inertia, gravity or any type of terrestrial or non-terrestrial reference is prohibited. Automatic control sequencing (pre-programming) or automatic control timing devices are prohibited.

Example:

Permitted:

1. Control rate devices that are manually switched by the pilot.
2. Any type of button or lever, switch, or dial control that is initiated or activated and terminated by the competitor.
3. Manually operated switches or programmable options to couple and mix control functions.

Not permitted:

1. Snap roll buttons with automatic timing mode.
2. Pre-programming devices to automatically perform a series of commands.
3. Auto-pilots or gyros for automatic wing levelling or other stabilisation of the model aircraft.
4. Automatic flight path guidance.
5. Propeller pitch change with automatic timing mode.
6. Any type of voice recognition system.
7. Any type of learning function involving manoeuvre to manoeuvre or flight to flight analysis.

5.9.3 Definition and Number of Helpers

A helper may be a Team Manager, another competitor or an officially registered supporter. Each competitor is permitted one helper (usually the caller) during the flight. One person, either a helper, or the team manager, or the caller, may place the model aircraft for take-off and retrieve the model aircraft following the landing. Physically disabled competitors requiring an additional helper and/or caller or other assistance, must request permission with full details, with their entry, from the organiser of a championship. This additional assistance must be provided by the competitor, must not give him an unfair advantage over other competitors, and must not unduly delay or interfere

with the running of the competition. Except for communication between the caller and the competitor, no other performance-enhancing communication with helpers is permitted during the flight.

5.9.4 **Number of Flights**

Competitors have the right to the same number of flights. Only completed rounds will be counted.

5.9.5 **Definition of an Attempt**

There is an attempt when the competitor is given permission to start.

If the propulsion device fails after the model aircraft becomes airborne, the attempt will be deemed complete.

5.9.6 **Number of Attempts**

Each competitor is entitled to one attempt for each official flight.

Note: An attempt can be repeated at the contest director's discretion only when any unforeseen reason beyond the control of the competitor, causes the model aircraft to fail to start (eg there is radio interference). Similarly, in a flight that is interrupted by any circumstance beyond the control of the competitor, the competitor is entitled to a reflight, with the entire schedule being flown and judged, but only the affected manoeuvre and the unscored manoeuvres that follow will be tabulated. This reflight should take place within 30 minutes of the first flight, in front of the same set of judges, or be the first flight after the judges' break, or, if it involves a protest, as soon as the FAI Jury has deliberated and communicated the outcome of the protest to the contest director. The result of the reflight will be final.

5.9.7 **Definition of an Official Flight**

There is an official flight when an attempt is made whatever the result.

5.9.8 **Marking**

- a) Each judge has to assess each manoeuvre and any other relevant action of the competitor individually and independently from the other judges. The criteria for judging the F3P-AA, F3P-AP and F3P-AF Aerobatics schedules are contained in the Description of Manoeuvres (Annex 5M) and in the Manoeuvre Execution Guide (Annex 5B). For F3P-AFM see Annex 5M Manoeuvres – Schedule F3P-AFM.
- b) Each F3P-AA, F3P-AP, F3P-AF manoeuvre may be awarded marks, by each of the judges during the flight. Every manoeuvre starts with the mark of 10 points and will be downgraded for each defect during the execution of the manoeuvre in one or multiple 0.5 point steps, depending on the severity of the defect. The remaining points result in the mark for the manoeuvre. During tabulation, these marks are multiplied by a coefficient (K-Factor) which relates to the difficulty of the manoeuvre.
- c) Any manoeuvre not completed, or flown out of sequence with the stated schedule shall be scored zero (0). Zero scores need not be unanimous, except in cases where an entirely wrong manoeuvre was performed. Judges must confer after the flight in these cases, bringing it to the attention of the flight line director/contest director on site.
- d) Take-off and landing procedures are not judged and are not scored.
- e) The manoeuvring area is limited by the floor, ceiling, and walls of the hall, as well as by the safety line which is parallel to the longest wall of the hall and in front of the judges. A model aircraft must never cross this safety line; otherwise the whole flight will be scored ZERO. The centre line of the manoeuvring area stretches from the safety line (perpendicular) to the opposite long wall, and is positioned in the middle between the side walls. The competitor is normally placed on the intersection of the safety line and the centre line.
- f) The recommended dimensions of the hall should be about 40 x 20 metres in length and width and between 8 to 12 metres in height.
- g) Centre manoeuvres should be performed such that equal amounts of the manoeuvres are on each side (left and right) of the centre line, with turn around manoeuvres at the left or right of it. Infractions of this rule will be cause for downgrading by each judge individually and in proportion to the degree of infraction.

Manoeuvres must be performed such that they can be seen clearly by the judges. If a judge, for some reason beyond the control of the competitor, is not able to follow the model aircraft through the entire manoeuvre, he may set the “Not Observed” (N.O.) mark. In this case, the judge’s mark for that particular manoeuvre will be the average of the numerical marks with 2 digits after the decimal point rounded up. If no such average is achievable, the competitor has the right for a reflight as per paragraph 5.9.6. If, for some reason within the control of the competitor, a judge is not able to follow the model aircraft through the entire manoeuvre, he has to downgrade the manoeuvre accordingly.

- h) Aerobatics Freestyle to Music (F3P-AFM) are judged for Precision and Accuracy, Complexity, Harmony of Flight to Music, Utilization of Manoeuvring Area and Special Effects, in marks of half number increments between 0 to 10 by each of the judges for the overall flight. as described in Annex 5M Manoeuvres – Schedule F3P-AFM.
- i) Judges shall be seated on a line parallel to the longest wall of the hall and in the middle between its side walls, while viewing the opposite longest wall. A raised platform for judges is recommended.
- j) If a model aircraft is, in the opinion of the judges, unsafe or being flown in an unsafe or inappropriate manner, they may bring this to the attention of the flight line director, who may instruct the pilot to land.
- k) The individual manoeuvre scores given by each judge for each competitor must be made public at the end of each flight of competition. The team manager must be afforded the opportunity to check that the scores on each judge’s score document correspond to the tabulated scores (to avoid data capture errors). The score board/monitor must be located in a prominent position at the flight line, in full view of the competitors and the public.

5.9.9 Classification

- a) For World and Continental Championships, each competitor will have four (4) preliminary flights for F3P Aerobatics with schedule F3P-AP; for F3P-AFM with competitors F3P-AFM schedule; with the best three normalised scores to determine the preliminary ranking. The top 30% (thirty percent) of the classified F3P AP competitors with a minimum of ten (10) will have three (3) additional flights. These final flights will be flown as a known finals schedule (schedule F3P-AF) for F3P Aerobatics Championship. The total of the best three preliminary flights of the finalists (normalised again to 1000 points) will count as one score. This score and the finals scores will give four (4) normalised scores. The sum of the three best will give the final classification. In the case of a tie, the sum of all the four (4) scores will determine the winner.

For the F3P-AFM Championship, the top 30% (thirty percent) of the classified F3P-AFM competitors with a minimum of ten (10) will have four (4) additional flights as described in Annex 5M Manoeuvres – Schedule F3P-AFM. The best of flight schedule 1 plus the best of schedule 2 will count for final ranking.

Note 1: Final flights to determine the individual winner are only required for World and Continental Championships for F3P Aerobatics (F3P-AP/F3P-AF) and F3P-Aerobatics Freestyle to Music (F3P-AFM).

- b) The team classification in F3P Aerobatic is established at the end of the competition (after the finals) by adding the numerical final placing of the best three team members of each nation. Teams are ranked from the lowest numerical scores to the highest, with complete three-competitor teams, ahead of two-competitor teams, which in turn are ranked ahead of one-competitor teams. In the case of a tie, the best individual placing decides the team ranking. For F3P AFM there will be no team ranking.

All competitors matching the junior definition as per CIAM General Rules C.15.6.1 are ranked in an additional junior classification.

- c) For World and Continental Championships, the scores for all rounds preliminary and finals, will be computed using the Tarasov-Bauer-Long (TBL) statistical averaging scoring system. Only computer tabulation systems containing the TBL algorithm and judge analysis programs that have been Subcommittee approved can be used at World and Continental Championships. To be eligible for approval a computer tabulation system has to be tested as recommended by the CIAM F3 Aerobatics Subcommittee Scoring Software Working Group.

- d) All scores for each round, preliminary and finals, will then be normalised as follows. The average score of the top half of competitors flown in front of a particular group of judges (ie a round) shall be awarded 1000 points. The remaining scores for that group of judges are normalised to a percentage of the 1000 points in the ratio of actual score over this average score.

$$Points_x = \frac{S_x}{S_w} \times 1000$$

$Points_x$ = points awarded to competitor X

S_x = score of competitor X

S_w = average score of top half of competitors of round

Note 1: Final flights to determine the individual winner are usually only required for World and Continental Championships. For open international events, national championships, and domestic competitions, the total of the three best preliminary flights out of four or the best two out of three may be used to determine the individual winner and team placing. Flights of Schedule F may be incorporated depending on local circumstances and the time available.

5.9.10 Judging

- For each competition in F3P, there must be a minimum of three (3), and a maximum of five (5) judges, plus one timer.
- For larger events, there might be several panels of judges.
- For World or Continental Championships, the organiser must appoint one or more panels of five judges each. The judges must be of different nationalities. Those selected must reflect the approximate geographical distribution of teams having participated in the previous World Championships and the final list must be approved by the CIAM Bureau. At least one third, but not more than two thirds of the judges must not have judged at the previous World Championship. Judge assignment to the panels will be by random draw.

In the case of more than one panel of judges, the panels may be combined for final rounds of flights.

- The invited judges for World or Continental Championships must be selected from the applicable list of current or upcoming approved FAI international judges and must have had a reasonable amount of F3P or F3A judging experience and must submit a resume of his judging experience to the organiser when accepting the invitation to judge at a World or Continental Championship. The organiser must in turn submit the resumes to the CIAM Bureau for approval.
- To avoid errant judging, it is recommended that training flights be performed, before the beginning of official flying. These training flights are judged and tabulated according to the regulations, but the results are not made public.

5.9.11 Organisation for R/C Indoor Aerobatic Contests

- Members of a National team, who have processed only one model aircraft each, may make use of the second model aircraft processed by another member of the same team. However, once that model has been used by a team member in that competition, it may not be used by any other competitor. If that team member did not process the model aircraft in the first place, then it must be re-registered and re-marked appropriately. This is the responsibility of the team manager.
- Only spread spectrum radio control systems are allowed.
- The flight order will be established by random draw, Team members will not be drawn to fly directly after each other. Competitor identification numbers will only be assigned after this flight order draw, in numerical ascending order.
- For flights two, three and four of the preliminary rounds the flight order will start $\frac{1}{4}$, $\frac{1}{2}$ and $\frac{3}{4}$ down the flight order respectively. Organisers must take care to avoid a flight draw which will cause competitors to fly at approximately the same time each day.
- The flight order for the first round of the finals in F3P Aerobatics will be established by a random draw as above. The flight order for flights two, and three will start $\frac{1}{3}$ and $\frac{2}{3}$ down the finals

flight order with decimals rounded-up.

- f) The flight order for the first round of the finals in F3P AFM will be established by a random draw as above. The flight order for flights two, and three and four will start 1/4, 2/4, 3/4 down the finals flight order with decimals rounded-up.
- g) Competitors must be called by a flight line official at least five minutes before they are required to occupy the starting area.
- h) For F3P-AA, F3P-AP and F3P-AF a competitor is allowed one (1) minute of starting time for connecting battery and checking radio equipment and five (5) minutes of flying time for each flight. Before the flight the model aircraft shall be placed in a starting box behind the safety line. The timing of an attempt starts when the contest director, or timekeeper, gives an instruction to the competitor to start and the 1-minute starting time begins. The starting time ends at the expiration of the 1-minute or when the model aircraft is removed from the starting box. If the model aircraft is not removed from the starting box by the expiration of the 1-minute starting time, the contest director/time keeper will advise the competitor and helper that the flight may not proceed. The flight shall score zero points. The openly displayed timing device/clock will be restarted to count the 5-min flying time when the model aircraft has been placed in take-off position beyond the safety line in the flying zone.
- i) With the expiry of the 5-minute flying time, the scoring will cease. The contest director/time keeper will advise the pilot, helper, and the judges of the expiry of the 5-minute flying time. The clock will be stopped when the wheels of the model aircraft touch the ground for landing, as proof to the competitor of the recorded time.
- j) For F3P-AFM a competitor is allowed one (1) minute of starting time for connecting battery and checking radio equipment. Then the competitor has to place the model to a take-off position beyond the safety line and may take off. Music starts when the competitor has signalled their wish to start the music to the operator of music. This has to be done within the first thirty (30) seconds after take-off. The duration of the music must be 120 +/- 5 seconds. Judging of the flight starts with the beginning of the music, the flight ends at the stopping of the music, or 125 seconds after the music had started. The model has to be landed immediately after the music has ended.
- k) The competitor may not start his model aircraft unless he has been instructed by a flight line official to do so. Deliberate starts at the flight line during official flying to check the propulsion device will be subject to disqualification from that round. No public address or commentary should be made during flights.
- l) During the flight, the competitor and his helper/caller (if required) must stay in the designated position in front of the judges. The competitor must wear or display their identification/start number.

5.9.12 Execution of Manoeuvres

F3P Aerobatics (Schedule F3P-AA, F3P AP, F3P-AF)

- a) In the preliminary flights (schedule F3P-AP) and the finals flights (schedule F3P-AF), the manoeuvres must be executed during an uninterrupted flight in the order that they are listed in the schedule. The competitor may make only one attempt at each scored manoeuvre during the flight. The direction of take-off is the pilot's choice. The direction of the first manoeuvre determines the direction of all following manoeuvres.
- b) The model aircraft must take-off and land unassisted, that is, no hand launched flights. If any part of the model aircraft is dropped or if it comes to stand still during the flight or being hung up on a wall or ceiling, scoring will cease at that point and the model must be landed immediately.
- c) In schedules with turn around manoeuvres, there is no unjudged flying between the first manoeuvre after the take-off and the last manoeuvre before landing.
- d) If the model aircraft touches the floor, ceiling, walls, or any structures or fixtures of the hall, this manoeuvre is scored ZERO.

F3P Freestyle Aerobatics to Music (F3P-AFM)

- e) The model aircraft must take-off and land unassisted, that is, no hand launched flights.
- f) If the model crosses the safety line the whole flight will be scored Zero.

- g) Judging is done for the entire flight, without interruption.
- h) If the model crashes and is not able to restart before one minute is over there will be no score. If the model is landed/crashed before the stopping of the music, or 125 seconds, there will be the following downgrades for all F3P-AFM Judging Criteria except special effects:
 - Time after starting music between 60 and 71 seconds - 5 points
 - Time after starting music between 72 and 83 seconds - 4 points
 - Time after starting music between 84 and 95 seconds - 3 points
 - Time after starting music between 96 and 107 seconds - 2 points
 - Time after starting music between 108 and 119 seconds - 1 point

5.9.13 **Schedule of Manoeuvres**

The schedule F3P-AA is recommended to be flown in local competitions, so as to offer advanced pilots a suitable way to achieve skills to step-up to schedules F3P-AP.

The schedule F3P-AP is a preliminary schedule for expert pilots in Indoor Aerobatic Power Model Aircraft competitions.

The schedule F3P-AF is a finals schedule for expert pilots in Indoor Aerobatic Power Model Aircraft competitions.

The schedule F3P-AFM is for competitors to demonstrate their artistic performances in Indoor Aerobatic Power Model Aircraft in conjunction with music.

The schedules begin on the following page:

ADVANCED SCHEDULE AA-21 (2020-2021)	K-Factor	
AA-21.01 Cuban Eight with half roll, half roll	K 3	
AA-21.02 Crossbox Stall Turn combination with quarter roll, quarter roll	K 3	
AA-21.03 Horizontal Triangle Circle with two half rolls opposite, roll	K 4	
AA-21.04 Half Reverse Cuban Eight with roll	K 3	
AA-21.05 Torque Roll	K 5	
AA-21.06 Half Square Loop on Corner	K 2	
AA-21.07 Knife-Edge Flight	K 3	
AA-21.08 Pull-Push-Pull Humpty Bump Crossbox Combination with quarter roll	K 3	
AA-21.09 Square Loop with half roll, half roll	K 5	
AA-21.10 Immelman	K 3	
AA-21.11 Double Key from Top	K 4	
	Total K = 38	

PRELIMINARY SCHEDULE AP-21 (2020-2021)	K-Factor	
AP-21.01 Knife-Edge Cuban Eight with quarter roll, half roll quarter roll	K 4	
AP-21.02 Crossbox Stall Turn combination with quarter roll, two consecutive quarter rolls, quarter roll	K 4	
AP-21.03 Horizontal Circle with two half rolls opposite integrated	K 5	
AP-21.04 Half Reverse Cuban Eight with half roll, half roll integrated	K 3	
AP-21.05 Three quarter Torque Roll, quarter Torque Roll in opposite direction with quarter rolls integrated into the quarter loops	K 5	
AP-21.06 Half Outside Loop, Loop	K 2	
AP-21.07 Knife-Edge Roll Combination with three quarter roll, half roll opposite, three quarter roll opposite	K 4	
AP-21.08 Figure Nine Crossbox Combination with quarter roll, two consecutive quarter rolls, half roll integrated	K 4	
AP-21.09 Square Loop on Corner with quarter roll, quarter roll	K 5	
AP-21.10 Comet with half roll, half roll	K 3	
AP-21.11 Double Key from Top with $\frac{1}{4}$ roll, $\frac{1}{4}$ roll	K 4	
	Total K = 43	

FINAL SCHEDULE AF-21 (2020-2021)	K-Factor	
AF-21.01 Half Hourglass with two consecutive one eighth rolls, quarter roll, half roll	K 4	
AF-21.02 Half Cuban Eight with roll integrated, two consecutive quarter rolls in opposite direction	K 3	
AF-21.03 Square Horizontal Eight with $\frac{1}{4}$ roll, $\frac{1}{2}$ roll, $\frac{1}{4}$ roll, $\frac{1}{4}$ roll, $\frac{1}{2}$ roll, $\frac{1}{4}$ roll	K 5	
AF-21.04 Pull-Push-Pull Humpty Bump with quarter roll, two consecutive opposite half rolls integrated, quarter roll	K 4	
AF-21.05 Horizontal Eight with half torque roll, half roll integrated, half torque roll, half roll integrated	K 6	
AF-21.06 Corner Combination with two consecutive quarter rolls, three quarter roll	K 2	
AF-21.07 Reverse Double Fighter Turn with quarter roll, half roll, half roll, quarter roll	K 6	
AF-21.08 Half Loop with integrated roll	K 3	
AF-21.09 Horizontal Square with quarter roll, quarter circle with half roll integrated, two consecutive quarter rolls, quarter circle with half roll integrated, knife edge loop, quarter circle with half roll integrated, two consecutive quarter rolls, quarter circle with half roll integrated, quarter roll	K 5	
AF-21.10 Trombone with three quarter roll, half roll integrated, three quarter roll	K 4	
AF-21.11 Double Stall Turn with quarter roll, half roll integrated, quarter roll	K 5	
	Total K = 47	

The descriptions of the manoeuvres and the Aresti diagrams for F3P-AP and F3P-AF appear in Annex 5M.

An explanation of the Aresti diagrams appears in F3A Annex 5A.

The Manoeuvre Execution Guide appears in F3A Annex 5B.

SCHEDULE F3P-AFM

AM1. Take-off

AM2. Freestyle (freely composed sequence of manoeuvres choreographed to music of the competitor's choice.)

AM3. Landing

The description of the manoeuvres for F3P-AFM appear at the end of Annex M.

ANNEX 5M**F3P – RADIO CONTROLLED INDOOR AEROBATIC AIRCRAFT
DESCRIPTION OF MANOEUVRES****Advanced – Schedule AA-21 (2020-2021)****II****AA-21.01 Cuban Eight with half roll, half roll**

From upright fly past center, perform a 5/8 loop into a 45 degree downline, perform a ½ roll, perform a ¾ loop into a 45 degree downline, perform a ½ roll, pull through a 1/8 loop, exit upright.

AA-21.02 Crossbox Stall Turn Combination with quarter roll, quarter roll

From upright, pull through a ¼ loop into a vertical upline, perform a ¼ roll, perform a stall turn into a vertical downline, push through a ¼ loop into a horizontal line, push through a ¼ loop into a vertical upline, perform a ¼ roll, perform a stall turn into a vertical downline, push through a quarter loop, exit inverted.

AA-21.03 Horizontal Triangle Circle with two half rolls opposite, roll

From inverted, fly past center, perform a 120 degree circle with wings level into a 60 degree crossbox line, perform consecutively two ½ rolls in opposite direction, perform another 120 degree circle with wings level into a 60 degree crossbox line, perform a roll, perform a third 120 degree circle with wings level, exit inverted.

AA-21.04 Half Reverse Cuban Eight with roll

From inverted, push through a 1/8 loop into a 45 degree upline, perform a roll, pull through a 5/8 loop, exit upright.

AA-21.05 Torque Roll

From upright, pull through a ¼ loop into a vertical upline, perform a torque roll, push through a 1/4 loop, exit upright.

AA-21.06 Half Square Loop on Corner

From upright push through a 1/8 loop, push through a ¼ loop, push through a 1/8 loop, exit inverted.

AA-21.07 Knife-Edge Flight

From inverted perform a ¼ roll into a sustained knife-edge flight, perform a ¼ roll, exit upright

AA-21.08 Pull Push Pull Humpty Bump Crossbox Combination with quarter roll

From upright, pull through a ¼ loop into a vertical upline, perform a ¼ roll, push through a ½ loop into a vertical downline line, pull through a ¼ loop into a horizontal line, perform a ¼ circle with wings level, exit upright.

AA-21.09 Square Loop with half roll, half roll

From upright, pull through a ¼ loop into vertical upline, pull through a ¼ loop, perform a ½ roll, push through a ¼ loop into vertical downline, push through a ¼ loop, perform a ½ roll, exit upright.

AA-21.10 Immelman

From upright, pull through a ½ loop immediately followed by a ½ roll, exit upright.

AA-21.11 Double Key from Top

From upright push through a ¼ loop into a vertical center downline push through a 5/8 loop into a 45 degrees upline, push through a ¼ loop into a 45 degrees downline, push through a 5/8 loop into a vertical center upline, push through a ¼ loop, exit upright

The Aresti diagram appears overleaf.

ADVANCED SCHEDULE AA-21 (2020-2021)

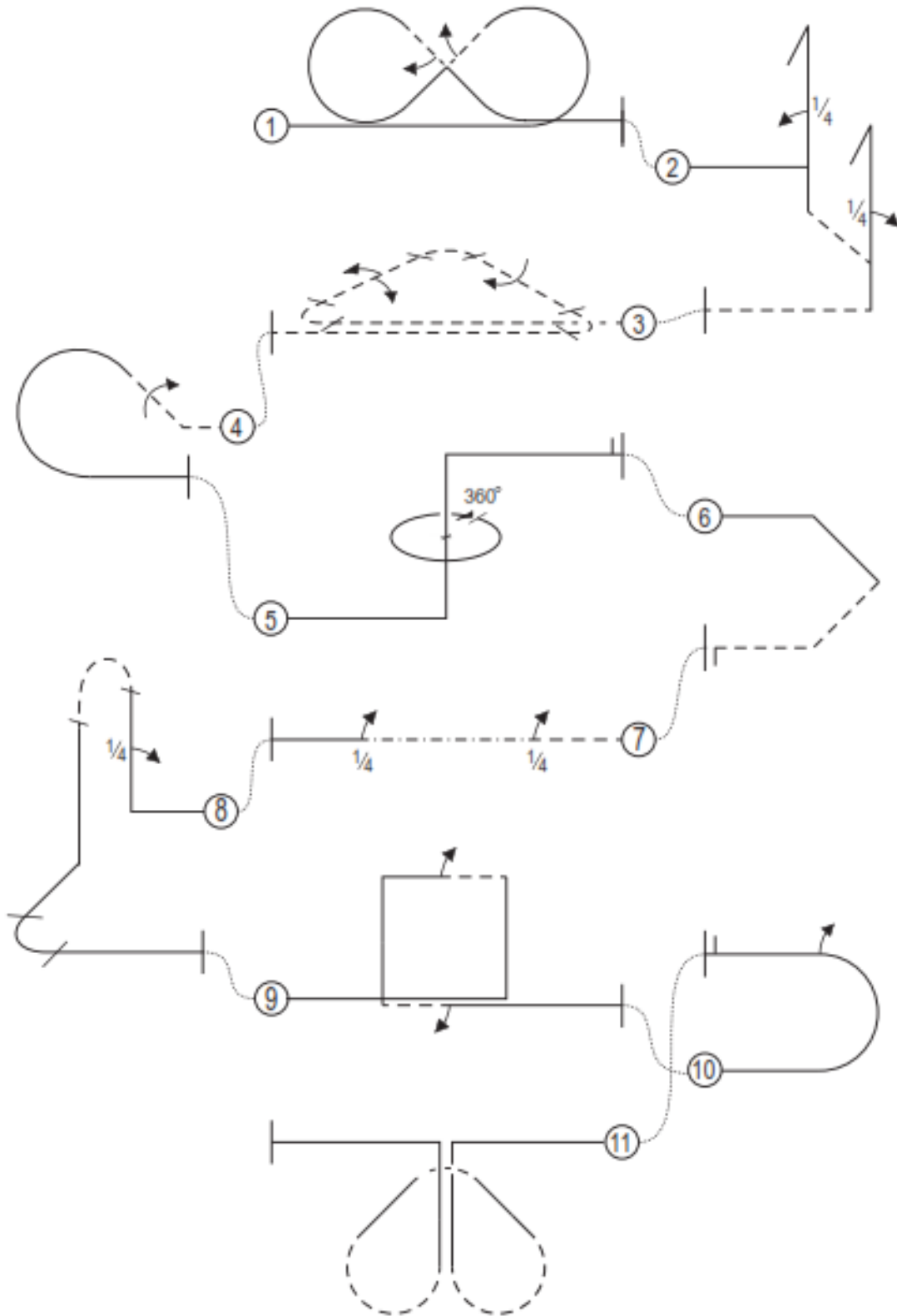

Preliminary Schedule AP-21 (2020-2021)**AP-21.01 Knife-Edge Cuban Eight with quarter roll, half roll, quarter roll**

From upright perform a $\frac{1}{4}$ roll in the center, perform a $\frac{5}{8}$ knife edge loop into a 45 degree downline, perform a $\frac{1}{2}$ roll, perform a $\frac{3}{4}$ knife edge loop into a 45 degree downline, perform a $\frac{1}{4}$ roll, push through a $\frac{1}{8}$ loop, exit inverted.

AP-21.02 Crossbox Stall Turn combination with quarter roll, two consecutive quarter rolls, quarter roll

From inverted, push through a $\frac{1}{4}$ loop into a vertical upline, perform a $\frac{1}{4}$ roll, perform a stall turn into a vertical downline, push through a $\frac{1}{4}$ loop into a horizontal line, perform consecutively two $\frac{1}{4}$ rolls, pull through a $\frac{1}{4}$ loop into a vertical upline, perform a $\frac{1}{4}$ roll perform a stall turn into a vertical downline, push through a quarter loop, exit inverted.

AP-21.03 Horizontal Circle with two half rolls opposite integrated

From inverted, perform a circle while integrating a $\frac{1}{2}$ roll to the outside and another $\frac{1}{2}$ roll to the inside, exit inverted.

AP-21.04 Half Reverse Cuban Eight with half roll, half roll integrated

From inverted, push through a one eighth loop into a 45 degree upline, perform a $\frac{1}{2}$ roll, push through a $\frac{5}{8}$ loop while integrating a $\frac{1}{2}$ roll into the last 180 degrees of the $\frac{5}{8}$ loop, exit upright.

AP-21.05 Three quarter Torque Roll, Quarter Torque Roll in opposite direction with quarter rolls integrated into the quarter loops

From upright, pull through a $\frac{1}{4}$ loop into a vertical upline while integrating a $\frac{1}{4}$ roll, perform a $\frac{3}{4}$ torque roll, perform a $\frac{1}{4}$ torque roll in opposite direction, perform a $\frac{1}{4}$ knife-edge loop while integrating a $\frac{1}{4}$ roll, exit upright.

AP-21.06 Half Outside Loop, Loop

From upright push through a $\frac{1}{2}$ outside loop, pull through a loop, exit inverted.

AP-21.07 Knife-Edge Roll Combination with three quarter roll, half roll opposite, three quarter roll opposite

From inverted perform a $\frac{3}{4}$ roll into knife-edge flight, perform a $\frac{1}{2}$ roll in opposite direction into knife-edge flight, perform a $\frac{3}{4}$ roll in opposite direction to the $\frac{1}{2}$ roll, exit inverted

AP-21.08 Figure Nine Crossbox Combination with quarter roll, two consecutive quarter rolls, half roll integrated

From inverted, push through a $\frac{3}{4}$ loop into a vertical downline, perform a $\frac{1}{4}$ roll, push through a $\frac{1}{4}$ loop into a horizontal line, perform consecutively two $\frac{1}{4}$ rolls, perform a $\frac{1}{4}$ circle while integrating a $\frac{1}{2}$ roll, exit inverted.

AP-21.09 Square Loop on Corner, with quarter roll, quarter roll

From inverted, push through a $\frac{1}{8}$ loop into a 45 degree upline, perform a quarter roll, perform a $\frac{1}{4}$ knife-edge loop into a 45 degree upline, perform a $\frac{1}{4}$ knife-edge loop into a 45 degree downline, perform a $\frac{1}{4}$ roll, pull through a $\frac{1}{4}$ loop into a 45 degrees downline, pull through a $\frac{1}{8}$ loop, exit upright.

AP-21.10 Comet with half roll, half roll

From upright, pull through a $\frac{1}{8}$ loop into a 45 degree upline, perform a $\frac{1}{2}$ roll, pull through a $\frac{3}{4}$ loop into another 45 degree upline, perform a $\frac{1}{2}$ roll, pull through a $\frac{1}{8}$ loop, exit inverted.

AP-21.11 Double Key from top with $\frac{1}{4}$ roll, $\frac{1}{4}$ roll

From inverted, pull through a $\frac{1}{4}$ loop into a vertical center downline pull through a $\frac{5}{8}$ loop into a 45 degrees upline, perform a $\frac{1}{4}$ roll, perform a $\frac{1}{4}$ knife-edge loop, perform a $\frac{1}{4}$ roll, push through a $\frac{5}{8}$ loop into a vertical center upline, push through a $\frac{1}{4}$ loop, exit upright

The Aresti diagram appears overleaf.

PRELIMINARY SCHEDULE AP-21 (2020-2021)

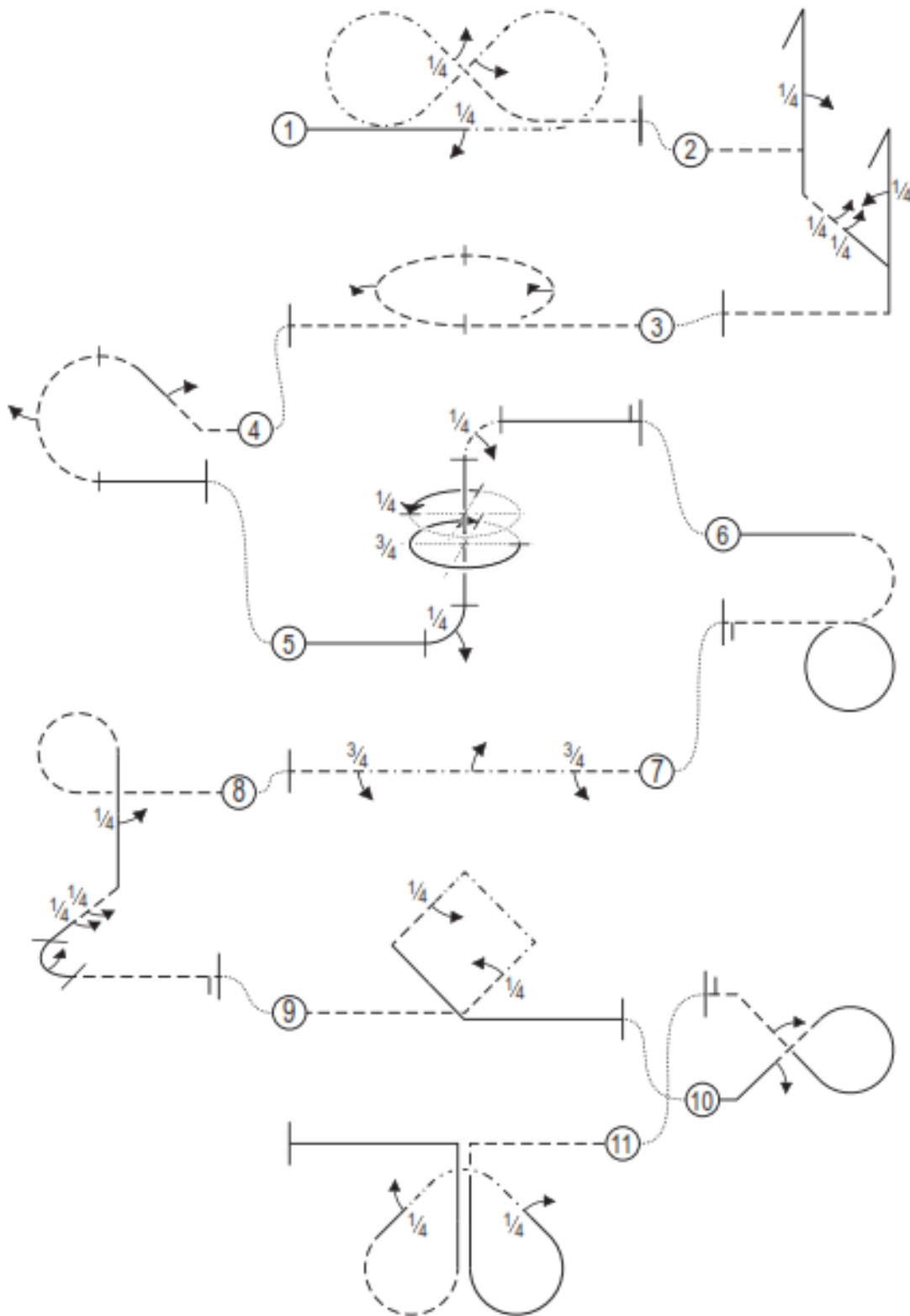

Final Schedule AF-21 (2020-2021)**AF-21.01 Half Hourglass with two consecutive one eighth rolls, quarter roll, half roll**

From upright, before reaching the center pull through a 1/8 loop perform consecutively two 1/8 rolls into a 45 degree knife-edge upline, perform a 3/8 knife edge loop into a horizontal line, perform a 1/4 roll, pull through a 3/8 loop into a 45 degree downline, perform a 1/2 roll, push through a 1/8 loop, exit inverted.

AF-21.02 Half Cuban Eight with roll integrated, two consecutive quarter rolls in opposite direction

From inverted, push through a 5/8 loop into a 45 degree downline, while integrating a roll within the first 180 degrees of the 5/8 loop, perform consecutively two 1/4 rolls in opposite direction, pull through a 1/8 loop, exit upright.

AF-21.03 Square Horizontal Eight with 1/4 roll, 1/2 roll, 1/4 roll, 1/4 roll, 1/2 roll, 1/4 roll

From upright, perform a quarter roll in the center, perform a 1/4 knife-edge loop into a vertical upline, perform a 1/2 roll, perform a 1/4 knife edge loop (against entry direction), perform a 1/4 roll into upright flight, push through a 1/4 loop into a vertical downline, pull through a 1/4 loop, perform a 1/4 roll into knife edge flight, perform a 1/4 knife-edge loop into a vertical upline, perform a 1/2 roll, perform a 1/4 knife edge loop into a horizontal line(in entry direction), perform a 1/4 roll into upright flight, push through a 1/4 loop into a vertical downline, pull through a 1/4 loop, exit upright.

AF-21.04 Pull-Push-Pull Humpty Bump with quarter roll, two consecutive opposite half rolls integrated, quarter roll

From upright, pull through a 1/4 loop into a vertical upline, perform a 1/4 roll, push through a 1/2 loop into a vertical downline, while integrating consecutively two 1/2 rolls in opposite direction, perform a 1/4 roll, pull through a 1/4 loop, exit upright

AF-21.05 Horizontal Eight with half torque roll, half roll integrated, half torque roll, half roll integrated

From upright, fly past center pull through a 1/4 loop, into a 1/2 torque roll, followed by a pushed 1/4 loop, push through a 1/4 loop, while integrating the first 1/4 of a 1/2 roll, while continuing rolling (second 1/4 of the 1/2 roll) push through a 1/4 loop, immediately push through a 1/4 loop, into a 1/2 torque roll, followed by a pulled 1/4 loop, pull through a 1/4 loop, while integrating the first 1/4 of a 1/2 roll, while continuing rolling (second 1/4 of the 1/2 roll) pull through a 1/4 loop, exit upright.

Note: Radius size and shape of the horizontal eight must be maintained.

AF-21.06 Corner Combination with two consecutive quarter rolls, three quarter roll

From upright, perform a 1/4 circle with wing level into a cross box line, perform consecutively two 1/4 rolls push through a 1/4 loop into a vertical upline, perform a 3/4 roll, pull through a 1/4 loop exit inverted.

AF-21.07 Reverse Double Fighter Turn with quarter roll, half roll, half roll, quarter roll

From inverted, pull through a 1/8 loop into a 45 degree downline, perform a 1/4 roll, push through a half knife edge circle into a 45 degree upline, perform a 1/2 roll, perform a 1/4 knife edge loop into a 45 degree downline, perform a 1/2 roll, push through a 1/2 knife edge circle into a forty five degree upline, perform a 1/4 quarter roll, pull through 1/8 loop, exit inverted.

AF-21.08 Half Loop with integrated roll

From inverted, pull through a 1/2 loop while integrating a roll, exit upright.

AF-21.09 Horizontal Square with quarter roll, quarter circle with half roll integrated, two consecutive quarter rolls, quarter circle with half roll integrated, knife edge loop, quarter circle with half roll integrated, quarter roll

From upright, perform a 1/4 roll in the center, perform a 1/4 circle while integrating a 1/2 roll, perform consecutively two 1/4 rolls, perform a 1/4 circle while integrating a 1/2 roll, perform a knife edge-loop, perform a 1/4 circle while integrating a 1/2 roll, perform consecutively two 1/4 rolls, perform a 1/4 circle while integrating a 1/2 roll, perform a 1/4 roll, exit upright.

AF-21.10 Trombone with three quarter roll, half roll integrated, three quarter roll

From upright, perform a 1/8 loop into a 45° upline, perform a 3/4 roll, perform a 1/2 knife-edge loop into a 45 degree downline while integrating a 1/2 roll, perform a 3/4 roll, push through a 1/8 loop, exit inverted.

AF-21.11 Double Stall Turn with quarter roll, half roll integrated, quarter roll

From inverted, fly past center, push through a 1/4 loop into a vertical upline, perform a 1/4 roll, perform a stall turn into a vertical downline, perform a 1/2 knife-edge loop into a vertical upline, while integrating a half roll, perform a stall turn into a vertical downline, perform a 1/4 roll, pull through a 1/4 loop, exit upright.

The Aresti diagram appears below.

FINAL SCHEDULE AF-21 (2020-2021)

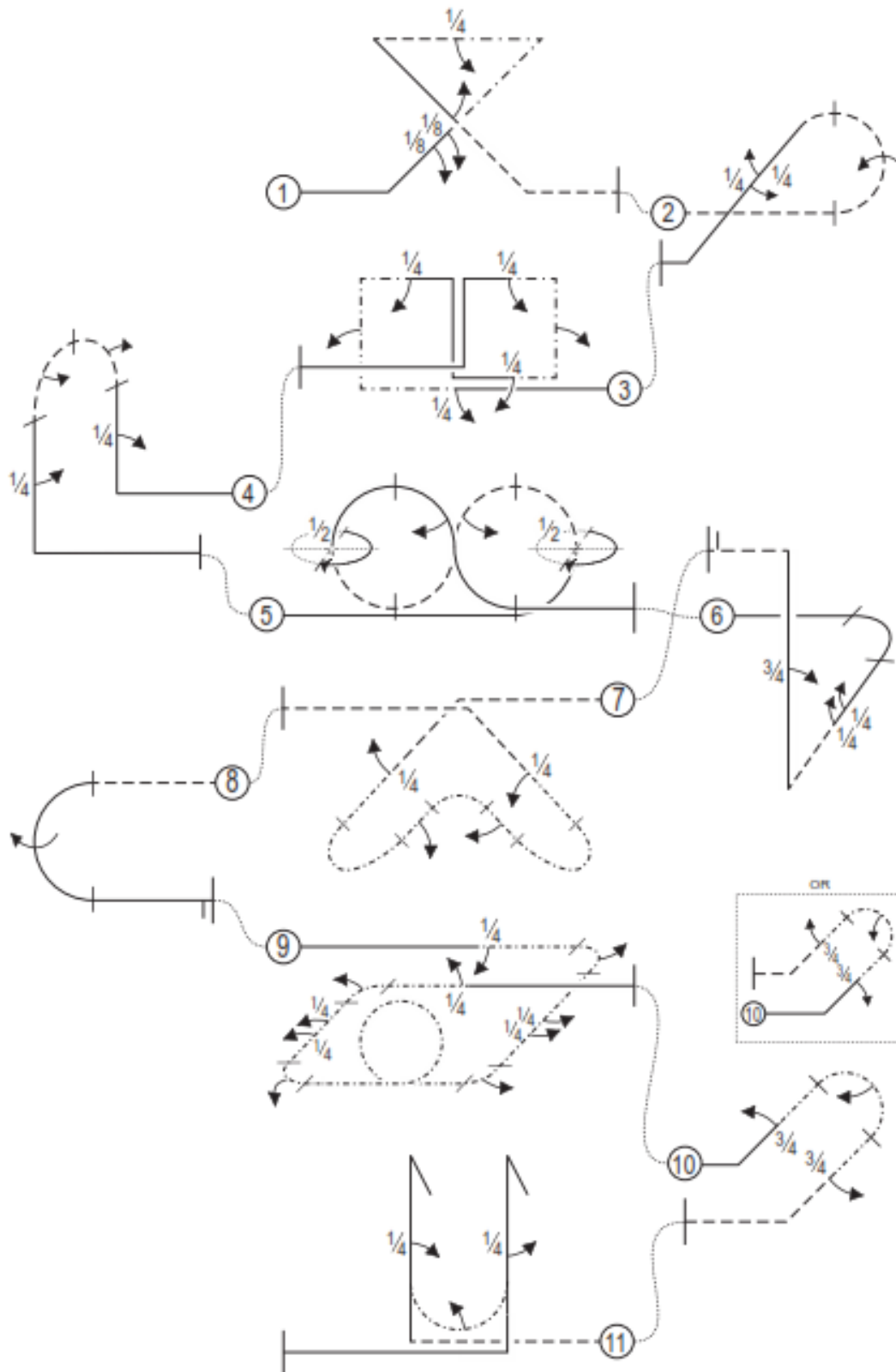

Manoeuvres – Schedule F3P-AFM

AFM1. Take-off Sequence

Place the model aircraft on the floor and take-off.

AFM2. Freestyle

A sequence of manoeuvres, freely composed by the competitor and flown in harmony to simultaneously played music of his choice. Any possible flight manoeuvres may be flown and "show effects" presented, as long as safety is not compromised and conformity to the rules is met. It is permitted to perform different programs in conjunction with different music in each round. For Final flights at World and Continental Championships, it is obligatory to have two different programs, schedule 1 and schedule 2, in conjunction with differently arranged music. Schedule 1 must be flown in final round one and three, Schedule 2 in final round two and four. The performance is judged for the entire flight from start to finish and in accordance to the following five criteria:

For Freestyle flights the judges can give up to the maximum points. The scores are given after the flight for all five criteria. It is important, that the scores for each criterion reflect the entire flight, not only some details of the flight.

Precision and Accuracy

K-20

The manoeuvres and figures should be executed with precision and accuracy, with the competitor demonstrating that he has the aircraft under full control in all attitudes. It should be clear to the judges that the manoeuvres flown, were in fact, intended and fully under the pilot's control. Higher marks will be given under this heading when individual manoeuvre elements are started and finished on obviously precise headings and well-defined attitudes.

Complexity

K-20

This criterion evaluates the level of difficulty and variety of manoeuvres of the freestyle flight. It is important, that the entire flight is to be judged, not only some highlights, so that the score reflects the average level of difficulty and variety. In addition, the pilot is to utilise the full flight performance scope of his model: fast and slow flying, snap manoeuvres, hovering etc. The manoeuvres should show positive as well as negative "g"-portions: loops, rolls, snaps, spins, stall-turns, tail-slides, hovering, torque-rolls, flat circles, Lomcevac, circles, etc. Frequent repetition of the same manoeuvre has to be downgraded respectively. Manoeuvres should be positioned in parallel or rectangular to the safety line. Poorly governed, unplanned or casually flown manoeuvres will be downgraded. The same applies to phases less extraordinarily attractive. Risky manoeuvres should never be mistaken as difficult manoeuvres. Risky manoeuvres must not lead to higher scores for difficulty, but result in a downgrade for safety.

Harmony of Flight to Music

K-30

The difficulty for competitors in AFM will be to fly perfectly in harmony and rhythm with a musical arrangement that they have selected themselves. The flight performance should be synchronised with the music and must not be a "3D-sketch" with background music.

The manoeuvres should follow the music and end with it. In AFM flights, the transformation of musical accents into the performance is of great importance.

The selected music piece(s) should flow through transitions, but contain fast-slow, soft-loud and dramatic sections. Dynamic and diversified sequences will lead to higher scores here. There should be a variety of different tempi in the presentation. The mood of the selected music should be reflected in the manoeuvres and the presentation. Flights to music pieces with little contrast, variety or tempi result in downgrades.

Marks should be deducted in this category for a flight that shows no relation between the rhythm of the evolutions and the music, therefore transforming the musical accompaniment to simple background music.

Utilisation of Manoeuvring Area

K-10

The presentation should fill the manoeuvring area. The performance should be orientated towards judges and spectators, although risky flying towards judges and spectators will result in downgrades.

Special Effects**K-10**

For special effects, additional points can be given (see Judges Notes).

Special effects may be used for making the presentation of the freestyle flight more spectacular through the use of:

Variable Propeller Pitch:

VPP may be used for creating special manoeuvres and special flight effects during the flight.

Streamers:

Streamers may be unfolded and dropped off during the flight. After dropping off they may still be used to enhance the flight by being crossed under or over flown by the model aircraft.

Confetti:

Confetti may be dropped from the model aircraft as a highlight during the flight.

Lights:

Lights can be a part of the model aircraft. They may be switched on and off during the flight or used to match the beat of the music.

Other:

Unspecified special effects that pilots elect to use or may create in the future.

Note: It is strictly forbidden to present special effects which use open fire effect equipment such as fireworks, smoke bombs or any other flammable materials.

Judges Notes:

F3P-AFM focuses on spectator and media efficacy. This is why the performances should be extraordinarily spectacular and entertaining under these aspects.

Judging of freestyle performance is more subjective and can't be done with methods used in F3P Aerobatics by deducting points. So, judging for Precision and Accuracy, Complexity, Harmony to Music and Utilisation of Manoeuvre Area should start around 5 and add or subtract as the flight progresses.

For each one of the Special Effects, judges may give a score up to two (2) points. If a special effect is presented during the whole flight, there should not be more than ½ point for this effect. If a special effect fails, there should be zero (0) points for this effect. The maximum score for special effects is ten (10), if five (5) special effects are presented.

Bias in favour of, or against, particular persons, models, music pieces etc must not influence the judging.

For the Judges it is recommended to make "pencil" notes right away during the presentation. So, corrections are still possible in the course of the flight. All criteria have to be marked simultaneously and evenly.

It is recommended for judges, to watch and judge AFM training flights to find a level and see some differences.

AFM3. Landing Sequence

The flight may be terminated in any kind of way provided it is performed in a safe manner.

5.12 CLASS F3S – RADIO CONTROLLED AEROBATIC JET MODEL AIRCRAFT**5.12.1 Definition of a Radio Controlled Aerobatic Jet Model Aircraft**

A model aircraft, but not a helicopter, which uses turbine jet(s) or ducted fan(s) as the propulsion source(s) and which is aerodynamically manoeuvred by control surface(s) in attitude, direction, and altitude by a pilot on the ground using radio control. Variable thrust direction of the propulsion device(s) is permitted.

5.12.2 General Characteristics of a R/C Aerobatic Jet Model Aircraft

The R/C Aerobatic Jet Model Aircraft shall use as a propulsion device turbo jet/s or ducted fan/s. Ducted fans may use turbo jet engines or electric motors as a power source. Rocket or pulse jet engines may NOT be used.

The number of model aircraft eligible for entry is two (2).

Maximum overall span 3500mm *

Maximum overall length 3500mm *

Maximum take-off weight with fuel (or with battery if EDF) 25 kg *

Electric Motors power source max. no load voltage 72 volts *

*A tolerance of 1% will be allowed for possible inconsistencies in measurement instruments for size, weight, and voltage unless otherwise stated.

The propulsion device(s) must automatically shut-off (EDF) or fully idle (turbo jet) at the moment an R/C signal failure occurs.

A maximum thrust of turbine is not defined, however limits for the competition area of the event have to be followed and must be submitted to the competitors.

Noise limits do not apply. If there is a noise limit for the competition area of the event, this must be submitted to the competitors.

Radio Equipment:

Radio equipment shall be of the open loop type (ie no electronic feedback from the model aircraft to the ground).

Permitted:

1. Control rate devices that are manually switched by the pilot.
2. Any type of button or lever, switch, or dial control that is initiated or activated and terminated by the competitor.
3. Manually operated switches or programmable options to couple and mix control functions.
4. The use of electronic stability augmentation devices or gyros with or without speed related automatic gain control derived from a GPS signal.
5. The transmission of information from the model aircraft to the pilot on the ground of propulsion and receiver system health monitoring.

Not permitted:

1. Snap roll buttons with automatic timing mode.
2. Pre-programming devices to automatically perform a series of commands, except for landing gear function.
3. Automatic flight path guidance.
4. Any type of voice recognition system.
5. Any type of learning function involving manoeuvre to manoeuvre or flight to flight analysis.

5.12.3. Definition and Number of Helpers

A helper may be a Team Manager, another competitor, or an officially registered supporter. Each competitor is permitted one helper (usually the caller) during the flight. Two helpers may be present and assist during the starting of the motor(s). One person, either a helper, or the team manager, or the caller, may place the model aircraft for take-off and retrieve the model aircraft following the landing. In exceptional circumstances, another helper may join the competitor and caller/helper during the flight, but only to hold a sun-shield as protection from direct sunlight. These protection devices must not interfere with the judges' vision of the manoeuvres.

Physically disabled competitors requiring an additional helper and/or caller or other assistance, must request permission with full details, with their entry, from the organiser of a championship. This additional assistance must be provided by the competitor, must not give him an unfair advantage over other competitors, and must not unduly delay or interfere with the running of the competition.

Except for communication between the caller and the competitor, no other performance-enhancing communication with helpers is permitted during the flight.

5.12.4. **Number of Flights**

Competitors have the right to the same number of preliminary, semi-final, or finals flights. Only completed rounds will be counted. Only when all competitors in the preliminary, semi-final, and final rounds, have had the opportunity to complete the same number of rounds, can the results of the rain-interrupted (or other delay) competition be determined.

5.12.5. **Definition of an Attempt**

There is an attempt when the competitor is given permission to start.

If the propulsion device fails after the model aircraft becomes airborne, the attempt will be deemed complete.

5.12.6. **Number of Attempts**

Each competitor is entitled to one attempt for each official flight.

Note: An attempt can be repeated at the contest director's discretion only when any unforeseen reason beyond the control of the competitor, causes the model aircraft to fail to start (eg there is radio interference). Similarly, in a flight that is interrupted by any circumstance beyond the control of the competitor, the competitor is entitled to a reflight, with the entire schedule being flown and judged, but only the affected manoeuvre and the unscored manoeuvres that follow will be tabulated. This reflight should take place within 30 minutes of the first flight, in front of the same set of judges, or be the first flight after the judges' break, or, if it involves a protest, as soon as the FAI Jury has deliberated and communicated the outcome of the protest to the contest director. The result of the reflight will be final.

5.12.7. **Definition of an Official Flight**

There is an official flight when an attempt is made whatever the result.

5.12.8. **Marking**

- a) Each judge has to assess each manoeuvre and any other relevant action of the competitor individually and independently from the other judges. The criteria for judging are contained in the Description of Manoeuvres (Annex 5M) and in the Manoeuvre Execution Guide (Annex 5B).
- b) Each manoeuvre may be awarded marks by each of the judges during the flight. Every manoeuvre starts with the mark of 10 points and will be downgraded for each defect during the execution of the manoeuvre in one or multiple 0.5 point steps, depending on the severity of the defect. The remaining points result in the mark for the manoeuvre. During tabulation, these marks are multiplied by a coefficient (K-Factor) which relates to the difficulty of the manoeuvre.
- c) Any manoeuvre not completed, or flown out of sequence with the stated schedule shall be scored zero (0). Zero scores need not be unanimous, except in cases where an entirely wrong manoeuvre was performed. Judges must confer after the flight in these cases, bringing it to the attention of the flight line director/contest director on site.
- d) Take-off and landing procedures are not judged and are not scored.
- e) The manoeuvring zone is vertically spread in front of and at a distance of approximately 150m - 200m from the pilot (depending on the size of the model aircraft). It is laterally limited by two virtual vertical planes above the extension of two lines on the ground each at an angle of 75 degrees left and right from the intersection of a centre line with the safety line. The centre line is positioned on the ground perpendicular to the safety line on the ground which is parallel to the runway. Two starting circles of 3m diameter are marked on the middle of the runway, one left and one right at minimum 15m off the centre line, also serving for sound/noise measurement, if required. The upper limit of the manoeuvring zone is defined by the virtual plane stretching up 60 degrees from the ground at the intersection of all ground lines.

- f) The dimensions, inertia and speed of a jet model aircraft have to be considered.
- g) The pilot is normally placed on the intersection of all ground lines.
- h) Manoeuvres must be performed such that they can be seen clearly by the judges. If a judge, for some reason beyond the control of the competitor, is not able to follow the model aircraft through the entire manoeuvre, he shall set the "Not Observed" (N.O.) mark. In this case, the judge's mark for that particular manoeuvre will be the average of the numerical marks with two digits after the decimal point, rounded up. If the majority of the judges scored "Not Observed", the competitor has the right for a reflight as per paragraph 5.12.6. If, for some reason within the control of the competitor, a judge is not able to follow the model aircraft through the entire manoeuvre, he has to downgrade the manoeuvre accordingly.
- i) Centre manoeuvres should be primarily performed in the centre of the manoeuvring zone while turn around manoeuvres should not extend past the lateral limits. Vertical height should not exceed the upper limit. Also, manoeuvres should be primarily performed along a line of flight approximately 150m - 200m in front of the safety line. Infractions of this rule will be cause for downgrading by each judge individually and in proportion to the degree of infraction. Exceptions to this rule are cross-box manoeuvres, 3D-manoevres, or manoeuvres in a stalled condition, as well as the horizontal circle manoeuvres which, of necessity, may deviate from the 150m - 200m distance of flight.
- j) The manoeuvring zone shall be clearly marked with white (or contrasting colour to the background) vertical poles, approximately 100mm in diameter and approximately 4m high, placed on centre and 75 degrees each side of centre on a line 150m in front of the competitor's position. Flags, streamers, or boards of contrasting colour to the background, should be mounted on the poles to improve visibility. White (or contrasting) lines, originating at the competitor's position and extending outward at least 50m, shall also be used to mark the centre and extreme limits (75 degrees left and right of centre) of the manoeuvring zone. Audible and visual signals to indicate violations of the manoeuvring zone must not be used.
- k) The judges shall be seated not more than 10m, and not less than 7m behind the competitor's position (the apex of the 75 degree lines) and within an area described by the extension of the 75 degree lines to the rear of the competitor. The judges must be seated abreast, usually separated by 2m, with scribes or score secretaries separating them.
- l) If a model aircraft is, in the opinion of the judges, unsafe or being flown in an unsafe or inappropriate manner, they may bring this to the attention of the flight line director, who may instruct the pilot to land.
- m) The individual manoeuvre scores given by each judge for each competitor must be made public at the end of each flight of competition. The team manager must be afforded the opportunity to check that the scores on each judge's score document correspond to the tabulated scores (to avoid data capture errors). The score board/monitor must be located in a prominent position at the flight line, in full view of the competitors and the public.

5.12.9 Classification

- a) For World and Continental Championships, each competitor will have four (4) preliminary flights with schedule F3SP with the best three normalised scores to determine the preliminary ranking. The top 30% (thirty percent) of the classified F3SP competitors with a minimum of ten (10) will have three (3) additional flights. These final flights will be flown as a known, finals schedule (schedule F3SF) The total of the best three preliminary flights of the finalists (normalised again to 1000 points) will count as one score. This score and the finals scores will give four (4) normalised scores. The sum of the three best will give the final classification. In the case of a tie, the sum of all the four (4) scores will determine the winner.

In the event of adverse weather where flying of all rounds is not possible the classification would be determined on rounds completed as follows:

Preliminaries: one round=one flight counts, two rounds= best one flight counts, three rounds= best two flights count.

Finals: one round = the total of the counting preliminary flights (normalised again to 1000 points) with the one Finals flight count.

Finals: two rounds = the sum of the two best of three (normalised preliminary, two finals rounds) count

- b) The team classification in F3S is established at the end of the competition (after the finals) by adding the numerical final placing of the best three team members of each nation. Teams are ranked from the lowest numerical scores to the highest, with complete three-competitor teams, ahead of two-competitor teams, which in turn are ranked ahead of one-competitor teams. In the case of a tie, the best individual placing decides the team ranking.

All competitors matching the junior definition as per CIAM General Rules C.15.6.1 are ranked in an additional junior classification.

- c) For World and Continental Championships, the scores for all rounds, preliminary and finals, will be computed using the Tarasov-Bauer-Long (TBL) statistical averaging scoring system. Only computer tabulation systems containing the TBL algorithm and judge analysis programs that have been Subcommittee approved can be used at Category 1 events.
- d) All scores for each round, preliminary and finals, will then be normalised as follows: The average score of the top half of competitors flown in front of a particular group of judges (ie a round) shall be awarded 1000 points. The remaining scores for that group of judges are normalised to a percentage of the 1000 points in the ratio of actual score over this average score.

$$\text{Points}_x = \frac{S_x}{S_w} \times 1000$$

Points_x = points awarded to competitor X

S_x = score of competitor X

S_w = average score of top half of competitors in round

Note 1: Final flights to determine the individual winner are usually required for World and Continental Championships.

For open international events, national championships, and domestic competitions, the best two out of three flights of Schedule P may be used to determine the individual winner and team placing.

Flights of Schedule F may be incorporated depending on local circumstances and the time available.

Note 2: The TBL score tabulation system can only be applied for events with at least 5 competitors and 5 judges.

5.12.10. Judging

Judging of jet aerobatics has to be according to Annex 5B by giving consideration to the dimensions, inertia and speed of a jet model aircraft.

- a) For each competition in F3S, there must be a minimum of three (3), and a maximum of five (5) judges, plus one timer.
- b) For larger events, there might be several panels of judges.
- c) For World or Continental Championships the organiser must appoint one or more panels of five judges each. The judges must be of different nationalities. Those selected must reflect the approximate geographical distribution of teams having participated in the previous World Championships and the final list must be approved by the CIAM Bureau. At least one third, but not more than two thirds of the judges must not have judged at the previous World Championship. Judge assignment to the panels will be by random draw.

In the case of more than one panel of judges, the panels may be combined for final rounds of flights.

- d) The invited judges for World or Continental Championships must be selected from the applicable list of current or upcoming approved FAI international judges and must have had a reasonable amount of F3A or F3S judging experience and must submit a resume of their judging experience to the organiser when accepting the invitation to judge at a World or Continental Championship. The organiser must in turn submit the resumes to the CIAM Bureau

for approval.

- e) To avoid errant judging, it is recommended that training flights be performed, before the beginning of official flying. These training flights are judged and tabulated according to the regulations, but the results are not made public.

5.12.11. Organisation for Radio Controlled Aerobatics Contests

- a) Members of a National team, who have processed only one model aircraft each, may make use of the second model aircraft processed by another member of the same team. However, once that model has been used by a team member in that competition, it may not be used by any other competitor. If that team member did not process the model aircraft in the first place, then it must be re-registered and re-marked appropriately. This is the responsibility of the team manager.
- b) Only spread spectrum radio control systems are allowed.
- c) The draw for flight order will be done for each flight line. Team members will not be drawn to fly directly after each other. Team members on separate flight lines will be separated by at least two competitors. Competitor identification numbers will only be assigned after this flight order draw, by competitor group, and in numerical ascending order.
- d) For flights two, three and four of the preliminary rounds the flight order will start $\frac{1}{4}$, $\frac{1}{2}$ and $\frac{3}{4}$ down the flight order respectively. Organisers must take care to avoid a flight draw which will cause competitors to fly at approximately the same time each day.
- e) The flight order for the first round of the finals in will be established by a random draw as above. The flight order for flights two, and three will start $\frac{1}{3}$ and $\frac{2}{3}$ down the finals flight order with decimals rounded-up.
- f) Competitors must be called by a flight line official at least five minutes before they are required to occupy the starting area.
- g) The competitor and his helper(s) then occupy the starting area so that a radio check can be performed to verify the correct functioning of the radio control equipment. The competitor must be allowed a maximum of one minute for a radio check before the beginning of the starting time.
- h) The time keeper will audibly notify the competitor when the minute is finished and immediately begin timing the starting time.
- i) According to paragraph 5.1.2., the voltage of the propulsion battery of electric powered models, must be checked by an official in the preparation area before the starting time is started.
- j) For electric powered models, the electric power circuit(s) must not be physically connected, before the starting time is begun and must be physically disconnected immediately after landing.
- k) A competitor is allowed six (6) minutes of starting time and eight (8) minutes of flying time for each flight. The timing of an attempt starts when the contest director, or timekeeper, gives an instruction to the competitor to start and the 6-min starting time begins. The competitor must be informed when 6-minutes of the starting time have elapsed. The openly displayed timing device/clock will be re-started to count the 8-min flying time when the model aircraft has been placed in the take-off circle. If the model aircraft is not placed with its wheels in the starting circle before/at the expiration of the 6-minute starting time, the contest director/time keeper will advise the competitor and helper that the flight may not proceed. The flight shall score zero points.

With the expiry of the 8-minute flying time, the scoring will cease except for the in-flight sound assessment, which is judged after the model aircraft has landed, irrespective of the time. The contest director/time keeper will advise the pilot, helper, and the judges of the expiry of the 8-minute flying time. The clock will be stopped at the end of the last manoeuvre as proof to the competitor of the recorded time.

- l) The competitor may not start his model aircraft unless he has been instructed by a flight line official to do so. Deliberate starts at the flight line during official flying to check the propulsion device will be subject to disqualification from that round. No public address or commentary should be made during flights.

- m) During the flight, the pilot and his helper/caller (if required) must stay in the designated position in front of the judges, at the convergence of the ground lines and under the supervision of the flight line director. The pilot must wear or display his identification/start number.

5.12.12. **Execution of Manoeuvres**

- a) The manoeuvres must be executed during an uninterrupted flight in the order in which they are listed in the schedule. The competitor may make only one attempt at each scored manoeuvre during the flight.
- b) The model aircraft must take-off and land unassisted, that is, no hand launched flights. If any part of the model aircraft is jettisoned during the flight, scoring will cease at that point and the competitor must be instructed by the flight line director to immediately land his model aircraft. Usually, the judges will be able to determine when a part has been jettisoned from the model aircraft. They should bring this to the attention of the flight line director on site.
- c) The direction of the first manoeuvre or the landing may be different from that of the take-off.
- d) After take-off, only turn-around manoeuvres, and not more than two (2), are allowed before starting the first manoeuvre of the schedule.

5.12.13 Schedule of Manoeuvres

The schedule F3S-B is recommended to be flown in local competitions so as to offer advanced pilots a suitable way to achieve skills to step-up to P- Schedules.

The schedule F3S-P is a preliminary schedule for expert pilots in Jet Aerobatic Power Model Aircraft competitions.

The schedule F3S-F is a finals schedule for expert pilots in Jet Aerobatic Power Model Aircraft competitions.

The schedule F3S-FS (Freestyle) is for competitors to demonstrate their artistic performances in Jet Aerobatic Power Model Aircraft in conjunction with music.

BASIC SCHEDULE SB-19 from 2019

	K Factor
SB-19.01: Loop	3
SB-19.02: Knife-Edge Flight	4
SB-19.03: Reverse Cuban 8 with 1/2 roll, 1/2 roll	4
SB-19.04: Figure 9 with roll up	3
SB-19.05: 45° Upline with ½ roll	3
SB-19.06: Slow roll	4
SB-19.07: Square Loop	4

PRELIMINARY SCHEDULE SP-19 from 2019

	K Factor
SP-19.01: Loop with roll integrated over top 90 degrees	4
SP-19.02: Half reverse Cuban 8 with ½ roll	2
SP-19.03: Knife-edge Flight	3
SP-19.04: Immelmann with ½ roll	2
SP-19.05: Reverse Cuban 8 from top with ½ roll, roll	4
SP-19.06: Half Loop	1
SP-19.07: Figure 9 with roll up	3
SP-19.08: Pull-push-pull Humpty Bump with ½ roll down	3
SP-19.09: 45° Upline with 3 consecutive ½ rolls	3
SP-19.10: Half Square Loop	2
SP-19.11: Slow roll	3
SP-19.12: Half Cuban 8 with ½ roll	2
SP-19.13: Square Loop with ½ roll, ½ roll	5

FINAL SCHEDULE SF19 from 2019

	K Factor
SF-19.01: Square Loop on corner with ½ roll, ½ roll, ½ roll, ½ roll	5
SF-19.02: Shark Fin with two consecutive ¼ rolls	3
SF-19.03: Knife-edge flight with roll	4
SF-19.04: Pushed Immelman with roll	2
SF-19.05: Rolling Loop	5
SF-19.06: Half Square Loop with ½ roll	2
SF-19.07: Figure 9 with with four consecutive ¼ rolls	4
SF-19.08: Pull-push-pull Humpty Bump with consecutive two ¼ rolls	3
SF-19.09: Avalanche	4
SF-19.10: Top Hat with two consecutive ¼ rolls, ½ roll	3
SF-19.11: Knife Edge Humpty Bump with ¼ roll, ¾ roll	4
SF-19.12: Half square loop on corner with half roll	3
SF-19.13: Reverse Nine with 3/4 roll, 3/4 roll	3
SF-19.14: Half reverse Cuban 8 with consecutive two ¼ rolls	3
SF-19.15: Roll Combination with four consecutive 1/8 rolls, four 1/8 rolls in opposite direction	4

For the description of the manoeuvres, judging notes, and Aresti diagrams, see Annex 5X.
For the Manoeuvre Execution Guide, see Annex 5B.

ANNEX 5X

F3S – RADIO CONTROLLED AEROBATIC JET MODEL AIRCRAFT DESCRIPTION OF MANOEUVRES

BASIC SCHEDULE F3S SB-19 (FROM 2019)

SB 19.01 Loop

From upright, pull through a loop, exit upright

SB 19.02 Knife edge Flight

From upright perform a $\frac{1}{4}$ roll into sustained Knife Edge Flight, perform a $\frac{1}{4}$ roll, exit upright.

SB 19.03 Reverse Cuban Eight with $\frac{1}{2}$ roll, $\frac{1}{2}$ roll

From upright, pull through a $\frac{1}{8}$ loop into a 45° upline, perform $\frac{1}{2}$ roll, pull through a $\frac{3}{4}$ loop into a 45° upline, perform a $\frac{1}{2}$ roll, pull through a $\frac{5}{8}$ loop, exit upright.

SB 19.04 Figure 9 with roll up

From upright, pull through a $\frac{1}{4}$ loop into a vertical upline, perform a roll, pull through a $\frac{3}{4}$ loop, exit upright.

SB 19.05 45° Upline with $\frac{1}{2}$ roll

From upright, pull into a 45 degree upline, perform a $\frac{1}{2}$ roll, pull through $\frac{1}{8}$ loop, exit inverted.

SB 19.06 Slow roll

From upright perform a slow roll, exit upright

SB 19.07 Square Loop

From upright, pull through a $\frac{1}{4}$ loop into a vertical upline, pull through a $\frac{1}{4}$ loop, pull through a $\frac{1}{4}$ loop into a vertical downline, pull through a $\frac{1}{4}$ loop, exit upright.

The Aresti diagram appears overleaf.

BASIC SCHEDULE F3S SB-19 (FROM 2019)

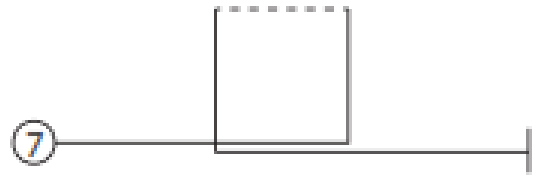
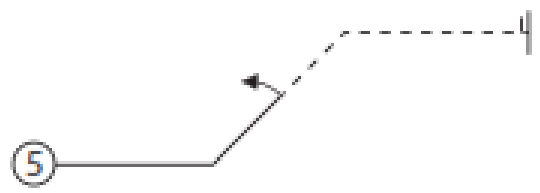
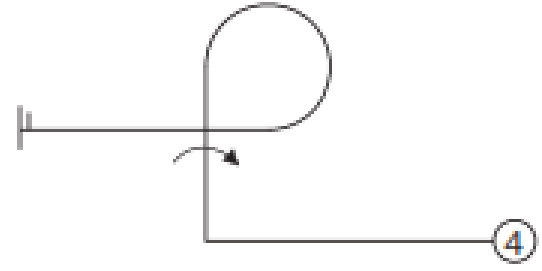
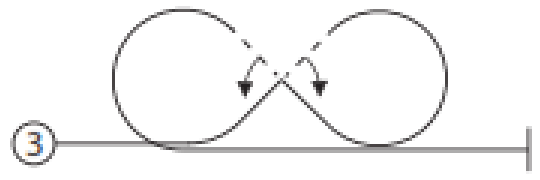
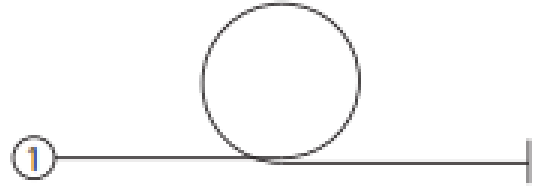

PRELIMINARY SCHEDULE F3S SP-19 (FROM 2019)**SP-19.01 Loop, with roll integrated over top 90 degrees**

From upright, pull through a loop while performing an integrated roll in the top 90 degrees of the loop, exit upright.

SP-19.02 Half Reverse Cuban 8 with $\frac{1}{2}$ roll

From upright, pull through a $\frac{1}{8}$ loop into a 45 degree upline, perform a $\frac{1}{2}$ roll, pull through a $\frac{5}{8}$ loop, exit upright.

SP-19.03 Knife-edge Flight

From upright, perform a $\frac{1}{4}$ roll to knife-edge flight, perform a $\frac{1}{4}$ roll, exit upright.

SP-19.04 Immelmann with $\frac{1}{2}$ roll

From upright, pull through a $\frac{1}{2}$ loop, immediately followed by $\frac{1}{2}$ roll, exit upright.

SP-19.05 Reverse Cuban 8 from top with $\frac{1}{2}$ roll, roll

From upright, push through a $\frac{1}{8}$ loop into a 45° downline, perform $\frac{1}{2}$ roll, push through a $\frac{3}{4}$ loop into a 45° downline, perform a roll, pull through a $\frac{5}{8}$ loop, exit inverted.

SP-19.06 Half Loop

From inverted, pull through a $\frac{1}{2}$ loop, exit upright.

SP-19.07 Figure 9 with roll up

From upright, pull through a $\frac{1}{4}$ loop into a vertical upline, perform a roll, pull through a $\frac{3}{4}$ loop, exit upright.

SP-19.08 Pull-push-pull Humpty Bump with half roll down

From upright, pull through a $\frac{1}{4}$ loop to a vertical upline, push through a $\frac{1}{2}$ loop into a vertical downline, perform a $\frac{1}{2}$ roll, pull through a $\frac{1}{4}$ loop, exit upright.

SP-19.09 45 ° Upline with three consecutive $\frac{1}{2}$ rolls

From upright, pull into a 45 degree upline, perform consecutively three $\frac{1}{2}$ rolls, pull through $\frac{1}{8}$ loop, exit inverted.

SP-19.10 Half Square Loop

From inverted, pull through a $\frac{1}{4}$ loop into a vertical downline, pull through a $\frac{1}{4}$ loop, exit upright.

SP-19.11 Slow roll

From upright, perform a slow roll, exit upright.

SP-19.12 Half Cuban 8 with $\frac{1}{2}$ roll

From upright, pull through a $\frac{5}{8}$ loop into 45° downline, perform a $\frac{1}{2}$ roll, pull through a $\frac{1}{8}$ loop exit upright.

SP-19.13 Square Loop with $\frac{1}{2}$ roll, $\frac{1}{2}$ roll

From upright, pull through a $\frac{1}{4}$ loop into a vertical upline, pull through a $\frac{1}{4}$ loop perform $\frac{1}{2}$ roll, push through a $\frac{1}{4}$ loop into a vertical downline, push through a $\frac{1}{4}$ loop, perform $\frac{1}{2}$ roll, exit upright.

The Aresti diagram appears overleaf.

PRELIMINARY SCHEDULE F3S SP-19 (From 2019)

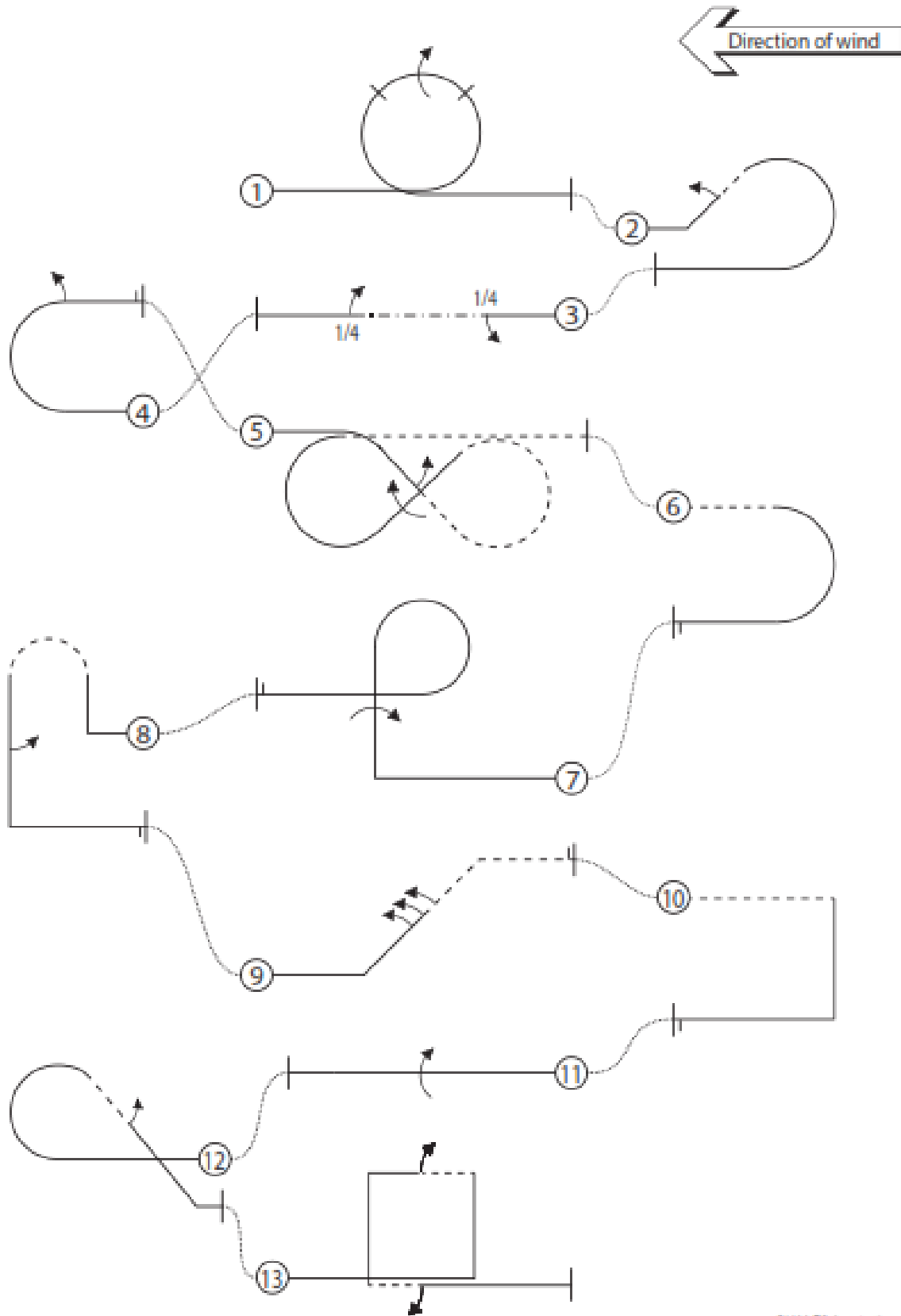

© CIAM F3 Aerobatics
Drawings by Ken Hiron
Feb. 2019

FINAL SCHEDULE F3S SF-19**SF-19.01 Square Loop on corner with ½ roll, ½ roll, ½ roll, ½ roll**

From upright, pull through a 1/8 loop into a 45 ° upline, perform a ½ roll, push through a ¼ loop into a 45 ° upline, perform a ½ roll, pull through a ¼ loop into a 45 ° downline, perform a ½ roll, push through a ¼ loop into a 45 ° downline, perform a ½ roll, pull through a 1/8 loop, exit upright.

SF-19.02 Shark Fin with two consecutive ¼ rolls

From upright, pull through a 1/8 loop into a 45 degree upline, perform consecutively two ¼ rolls, pull through a 3/8 loop, pull through a ¼ loop, exit upright.

SF-19.03 Knife-edge Flight with roll

From upright, perform a ¼ roll, perform a knife-edge flight, perform a roll in opposite direction to the ¼ roll, perform a knife-edge flight, perform a ¼ roll in opposite direction to the roll, exit inverted.

SF-19.04 Pushed Immelman with roll

From inverted, push through a half loop, immediately followed by a roll, exit upright.

SF-19.05 Rolling Loop

From upright, push through a loop while integrating one roll, exit upright.

SF-19.06 Half Square Loop with ½ roll

From upright, push through a ¼ loop, perform a ½ roll, pull through a ¼ loop, exit upright.

SF-19.07 Figure 9 with four consecutive ¼ rolls

From upright, pull through a ¼ loop into a vertical upline, perform consecutively four ¼ rolls, pull through a ¾ loop, exit upright.

SF-19.08 Pull-push-pull Humpty Bump with consecutive two ¼ rolls

From upright, pull through a ¼ loop to a vertical upline, push through a 1/2 loop into a vertical downline, perform consecutively two ¼ rolls, pull through a ¼ loop, exit upright.

SF-19.09 Avalanche

From upright, pull through a loop, while performing a snap roll on top, exit upright.

SF-19.10 Top Hat with two consecutive ¼ rolls, ½ roll

From upright, pull through a ¼ loop into a vertical upline, perform consecutively two ¼ rolls, pull through a ¼ loop into a horizontal line, pull through a ¼ loop into a vertical downline, perform a ½ roll, push through a ¼ loop, exit inverted.

SF-19.11 Knife Edge Humpty Bump with ¼ roll, ¾ roll

From inverted, fly past center, push through a ¼ loop into a vertical upline, perform a ¼ roll, perform a ½ knife edge loop into a vertical downline, perform a ¾ roll, push through a ¼ loop, exit inverted.

SF-19.12 Half Square Loop on corner with half roll

From inverted, push through a 1/8 loop into a 45° upline, perform a ½ roll, pull through a ¼ loop into a 45° degrees upline, pull through a 1/8 loop, exit inverted.

SF-19.13 Reverse Nine with ¾ roll, ¾ roll

From inverted push through a 7/8 loop into a 45 degree downline perform consecutively two ¾ rolls in opposite direction, push through a 1/8 loop, exit inverted.

SF-19.14 Half reverse Cuban 8 with roll

From inverted, push through a 1/8 loop into a 45° upline, perform a roll, pull through a 5/8 loop, exit upright.

SF-19.15 Roll Combination with four consecutive 1/8 rolls, four 1/8 rolls in opposite direction

From upright perform consecutively 4 1/8 rolls, four 1/8 rolls in opposite direction.

The Aresti diagram appears overleaf.

FINAL SCHEDULE F3S SF-19 (From 2019)

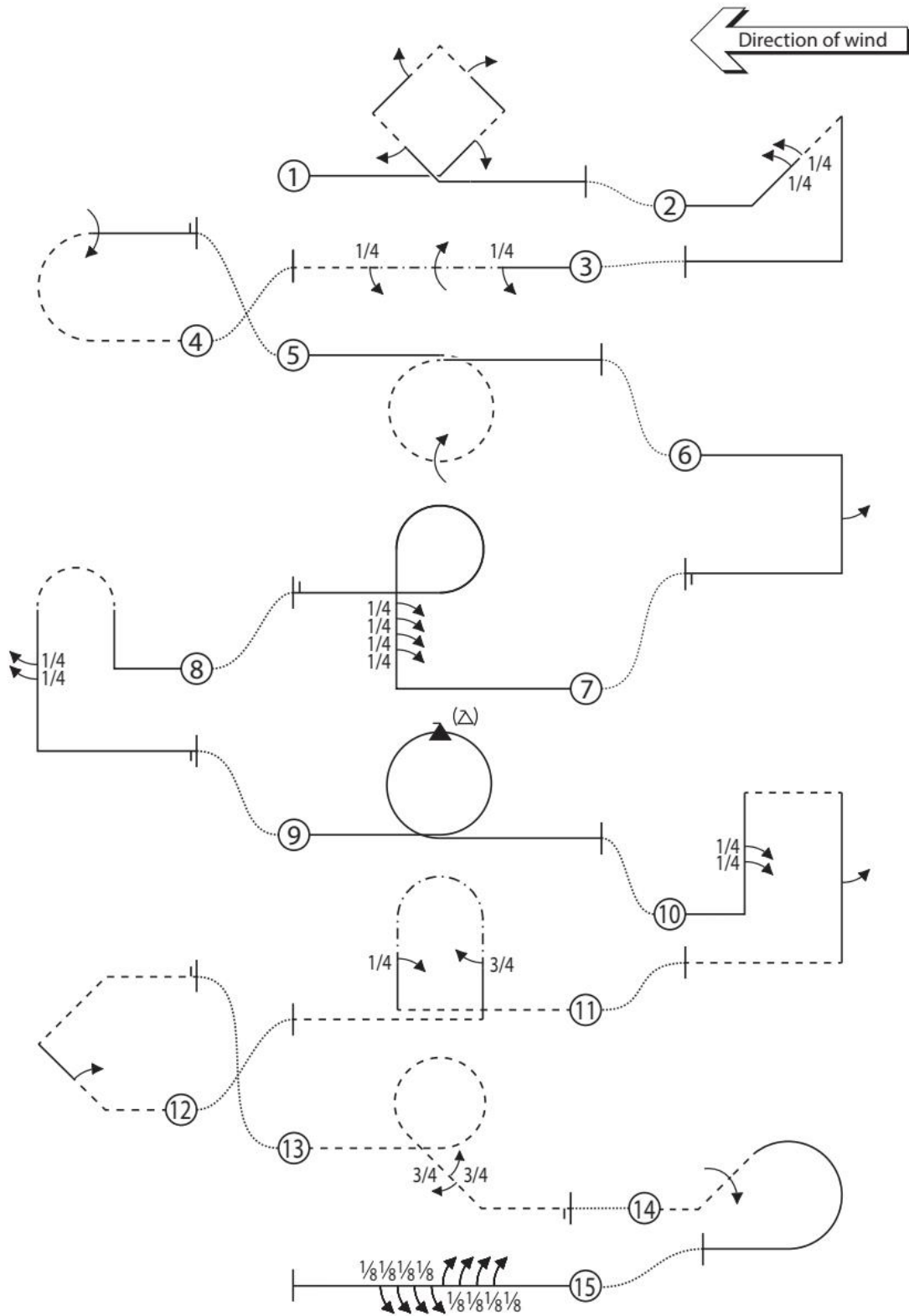

© CIAM F3 Aerobatics
 Drawings by Ken Hirose
 Feb. 2019

F3S-individual Freestyle (F3S-FS), added event

After the competition flights with schedule SP and SF, one or two Freestyle Rounds may be held as part of the event, with an independent classification, depending on local circumstances and the time available.

Every competitor who takes part in the competition has the right to take part at the freestyle round, with one of the two models registered in the competition at his choice.

The freestyle event can be held only with a minimum of 5 competitors or more.

The total of the round (normalised to 1000 points) will count as final classification for the individual Freestyle competition.

The allowed starting time is six (6) minutes. The competitor must be informed when five (5) minutes of the starting time have elapsed.

Music starts when the competitor has signalled his wish to start the music to the operator of music. This has to be done within the first thirty (30) seconds after take-off. The duration of the music must be five (5) minutes +/- 5 seconds. Judging of the flight starts with the beginning of the music, the flight ends at the stop of the music. The model has to be landed immediately after the music has ended or with ending of the music.

FS 1. Take-off Sequence

Place the model aircraft on the ground and take-off.

FS 2. Freestyle

A sequence of manoeuvres, freely composed by the competitor and flown in harmony to simultaneously played music of his choice. Any possible flight manoeuvres may be flown and "show effects" presented, as long as safety is not compromised and conformity to the rules is met. It is permitted to perform different programs in conjunction with different music in each round. The performance is judged for the entire flight from start to finish and in accordance to the following **five** criteria:

For Freestyle flights the judges can give up to the maximum points. The scores are given after the flight for all **five** criteria. It is important, that the scores for each criterion reflect the entire flight, not only some details of the flight.

Precision and Accuracy

K-20

The manoeuvres and figures should be executed with precision and accuracy, with the competitor demonstrating that he has the aircraft under full control in all attitudes. It should be clear to the judges that the manoeuvres flown, were in fact, intended and fully under the pilot's control. Higher marks will be given under this heading when individual manoeuvre elements are started and finished on obviously precise headings and well-defined attitudes

Complexity

K-20

This criterion evaluates the level of difficulty and variety of manoeuvres of the freestyle flight. It is important, that the entire flight is to be judged, not only some highlights. So the score reflects the average level of difficulty and variety. In addition, the pilot is to utilise the full flight performance scope of his model. Fast and slow flying, snap manoeuvres, hovering etc. The manoeuvres should show positive as well as negative "g"-portions: loops, rolls, snaps, spins, stall-turns, tailslides, hovering, torque-rolls, flat circles, Lomcevac, circles, etc. Frequent repetition of the same manoeuvre has to be downgraded respectively. Manoeuvres should be positioned in parallel or rectangular to the safety line. Poorly governed, unplanned or casually flown manoeuvres will be downgraded. The same applies to phases less extraordinarily attractive.

Risky manoeuvres should never be mistaken as difficult manoeuvres. Risky manoeuvres must not lead to higher scores for difficulty, but result in a downgrade for safety.

Harmony of Flight to Music

K-30

The difficulty for competitors in F3S_FS will be to fly perfectly in harmony and rhythm with a musical arrangement that they have selected themselves. The flight performance should be synchronized with the music and must not be a flying with background music.

The manoeuvres should follow the music and end with it. In F3S FS flights, the transformation of musical accents into the performance is of great importance.

The selected music piece(s) should flow through transitions, but contain fast-slow, soft-loud and dramatic sections. Dynamic and diversified sequences will lead to higher scores here. There should be a variety of different tempi in the presentation. The mood of the selected music should be reflected in the manoeuvres and the presentation. Flights to Music pieces with little contrast, variety or tempi result in downgrades.

Marks should be deducted in this category for a flight that shows no relation between the rhythm of the evolutions and the music, therefore transforming the musical accompaniment to simple background music.

Utilization of Manoeuvring Area

K-10

The presentation should fill the manoeuvring area. The performance should be orientated towards judges and spectators, although risky flying towards judges and spectators will result in downgrades.

Special Effects

K-10

For special effects, additional points can be given. (see Judges Notes)

Special effects may be used for making the presentation of the freestyle flight more spectacular through the use of:

Smoke:

Main turbine smoke and wing tips smoke may be used to emphasise the freestyle manoeuvres in a positive way (max. 5 points)

Lights can be a part of the model aircraft. They may be switched on and off during the flight or used to match the beat of the music. (max. 2,5 points)

Other:

Unspecified special effects that pilots elect to use or may be created in the future. (max, 2,5 points)

Judges Notes:

F3S-FS focuses on spectator and media efficacy. This is why the performances should be extraordinarily spectacular and entertaining under these aspects.

Judging of freestyle performance is more subjective and can't be done in the manner used in F3S Aerobatics P and F schedules by deducting points. So judging for Precision and Accuracy, Complexity, Harmony to Music and Utilisation of Manoeuvre Area should start around 5 and add or subtract as the flight progresses.

For Special Effect Smoke, judges may give a score up five (5) points. For other Special Effects up to two and a half (2,5) points. If a special effect is presented during the whole flight, there should not be more than ½ point for this effect. If a special effects fails, there should be zero (0) points for this effect. The maximum score for special effects is ten (10), if four (4) special effects are presented.

Bias in favour of, or against, particular persons, models, music pieces etc must not influence the judging.

For the Judges it is recommended to make "pencil" notes during the presentation. So corrections are still possible in course of the flight. All criteria have to be marked simultaneously and evenly.

It is recommended for judges to watch and judge Freestyle training flights to find a level and see some differences.

FS 3. Landing Sequence

Landing has to be done in a safe manner.

ANNEX 5N

RULES FOR WORLD CUP EVENTS

F3A, F3P & F3M AEROBATIC WORLD CUP

5N.1. Class

The F3A, F3P and F3M classes are recognised for World Cup competition (aerobatic model aircraft).

5N.2. Competitors

All competitors in the specified open international contests are eligible for the World Cup.

5N.3. Contests

Contests included in the World Cup must appear on the FAI Contest Calendar, and must be run according to the FAI Sporting Code. The contests eligible for a World Cup in a particular year, must be nominated before the CIAM Bureau Meeting at the end of the preceding year, and must be included in the FAI Contest Calendar. The selection of the contests should be according to the following guidelines:

- a) a maximum of two contests may be selected for any one country.
- b) each competitor may count only one competition from each country in Europe (taking the better score for any European country in which he has scored in two competitions).
- c) five (5) judges have to be appointed for each judges' panel and a TBL scoring system has to be applied.
- d) rounds should be organised in one of the following combinations, while rounds of F-Schedules may be run for a limited number of competitors only as a "fly-off".
 - Four rounds of P-schedule, two rounds of F-schedule. The total of the best three preliminary flights (normalised again to 1000 points) will count as one score along with the two fly-off scores to provide three scores, the best two to count for classification.
 - Three rounds of P-Schedule with the best two flights counting
 - Two rounds of P-Schedule with the best one flight plus one round of F-Schedule counting
 - Three rounds of P-Schedule with the best two flights plus one round of F-Schedule counting

Other combinations are subject to be confirmed by the World Cup Coordinator or the F3 Aerobatics Chairman in advance.
- e) rounds to be flown must be published in Bulletins and all rounds completed have to count for the only one overall result of each World Cup competition.

5N.4. Points allocation

The World Cup points to be allocated to competitors according to their place in the results will depend on the number (N) of competitors who have completed at least one flight in the event with a normalised result of minimum 750.00 points.

5N.4.1. Class F3A

a) $N > 20$

Placing	1	2	3	4	5	6	20	21 and after
Points	20	19	18	17	16	15	1	0

A bonus of 8 points is given to the first placed competitor; 5 points to the second placed and 3 points to the third placed.

b) $N \leq 20$

Placing	1	2	3	4	5	6	N-1	N
Points	N	N-1	N-2	N-3	N-4	N-5	2	1

The bonus is defined as follows:

- for first place: $N/3$ rounded up to the nearest whole number of points, with a maximum of 7 points;
- for second place: $N/5$ rounded up to the nearest whole number of points, with a maximum of 4 points;
- for third place: $N/7$ rounded up to the nearest whole number of points, with a maximum of 3 points.

In the event of a tie between competitors for any placing, the competitors will share the points which would have been awarded to the places covered had the tie been resolved (round up the score to the nearest whole number of points).

5N.4.2. Classes F3M and F3P

a) $N > 15$

Placing	1	2	3	4	5	6	15	16 and after
Points	15	14	13	12	11	10	1	0

A bonus of 8 points is given to the first placed competitor; 5 points to the second placed and 3 points to the third placed.

b) $N \leq 15$

Placing	1	2	3	4	5	6	N-1	N
Points	N	N-1	N-2	N-3	N-4	N-5	2	1

The bonus is defined as follows:

- For first place: $N/3$ rounded up to the nearest whole number of points, with a maximum of 7 points;
- For second place: $N/5$ rounded up to the nearest whole number of points, with a maximum of 4 points;
- For third place: $N/7$ rounded up to the nearest whole number of points, with a maximum of 3 points.

In the event of a tie between competitors for any placing, the competitors will share the points which would have been awarded to the places covered had the tie been resolved (round up the score to the nearest whole number of points).

5N.5. Classification

The World Cup results are determined by considering the total of points obtained by each competitor in the World Cup events. Up to three events may be counted, selecting each competitor's best scores during the year. The winner of the World Cup is the competitor with the greatest total.

In the event of a tie for first, second, and third place, the place will be determined according to the following criteria:

The number of events counted is increased, one at a time, from three until the winner is obtained. If this does not separate the tied competitors, then the winner will be determined by considering the points obtained in the best three events multiplied by the number of competitors who have completed at least one flight in the event. The winner is the one with the greatest total thus calculated.

5N.6. Awards

The winner is awarded the title of winner of the World Cup. Certificates, medals and trophies may be awarded by the CIAM F3 Aerobatics sub-committee if available.

5N.7. Organisation

The F3 Aerobatics sub-committee shall be responsible for organising the World Cup, and may nominate a responsible person or special sub-committee to collate the results.

cont/...

5N.8. Communication

The F3 Aerobatics sub-committee nominated World Cup coordinator must receive the results from each contest in the World Cup, and then calculate and publish the World Cup positions. These should be distributed to the news agencies and should also be available, by payment of a nominal fee, to any interested bodies or individuals. Final results of the World Cup must be sent to the FAI, National Airports Controls, and the modelling press.

5N.9. Responsibilities of competition organisers

Competition organisers must propose their event for inclusion in the World Cup, when nominating events for the FAI international Sporting Calendar. The final selection of events from these proposals is made by the CIAM Bureau as defined in paragraph 3.

Immediately after the event, the competition organiser must send the results to the World Cup coordinator, within one month as required in the Sporting code B.2.5. Any failure to return scores promptly will be reviewed by the CIAM Bureau when considering the competition calendar for the following year.

5N.10. World Cup Board

A Board of three persons shall be nominated by the CIAM Aerobatic Subcommittee Chairman to rule on any issue concerning the implementation of World Cup rules during a year. Any such issue must be submitted in writing to the Aerobatic Subcommittee Chairman. The World Cup Board is not entitled to deal with any kind of complaint or protest concerning a single competition, which must be considered by the FAI Jury for that competition.

---oOo---